

Vo!

Volu

men





Volumen is a design-oriented brand from Bosnia and Herzegovina which creates modern, functional and highly comfortable furniture. Volumen furniture is unassuming and it represents a modern take on classical values. Volumen is an epitome of the optimal balance between form and content – the design is modern, smart and meticulously conceived, while the materials are of superior quality.



We perceive design as a subtle interplay between aesthetics and functionality. We therefore dedicate our utmost attention to details, and treat resources responsibly. Our goal is to create high-quality, yet accessible furniture which fulfils the requirements of modern lifestyles. Due to the decades-long experience in all the phases of the production process, we now have endless options at our disposal when creating innovative and modern solutions. By merging traditional values, manufacturing expertise and understanding of the needs of today's individual, we make the furniture for which we believe that it elevates the quality of life. Volumen represents a mixture of high quality craft and state-of-the-art technology. The quality is directly guaranteed through cycle testing in our own manufacturing facilities. We comply with all FSC standards.



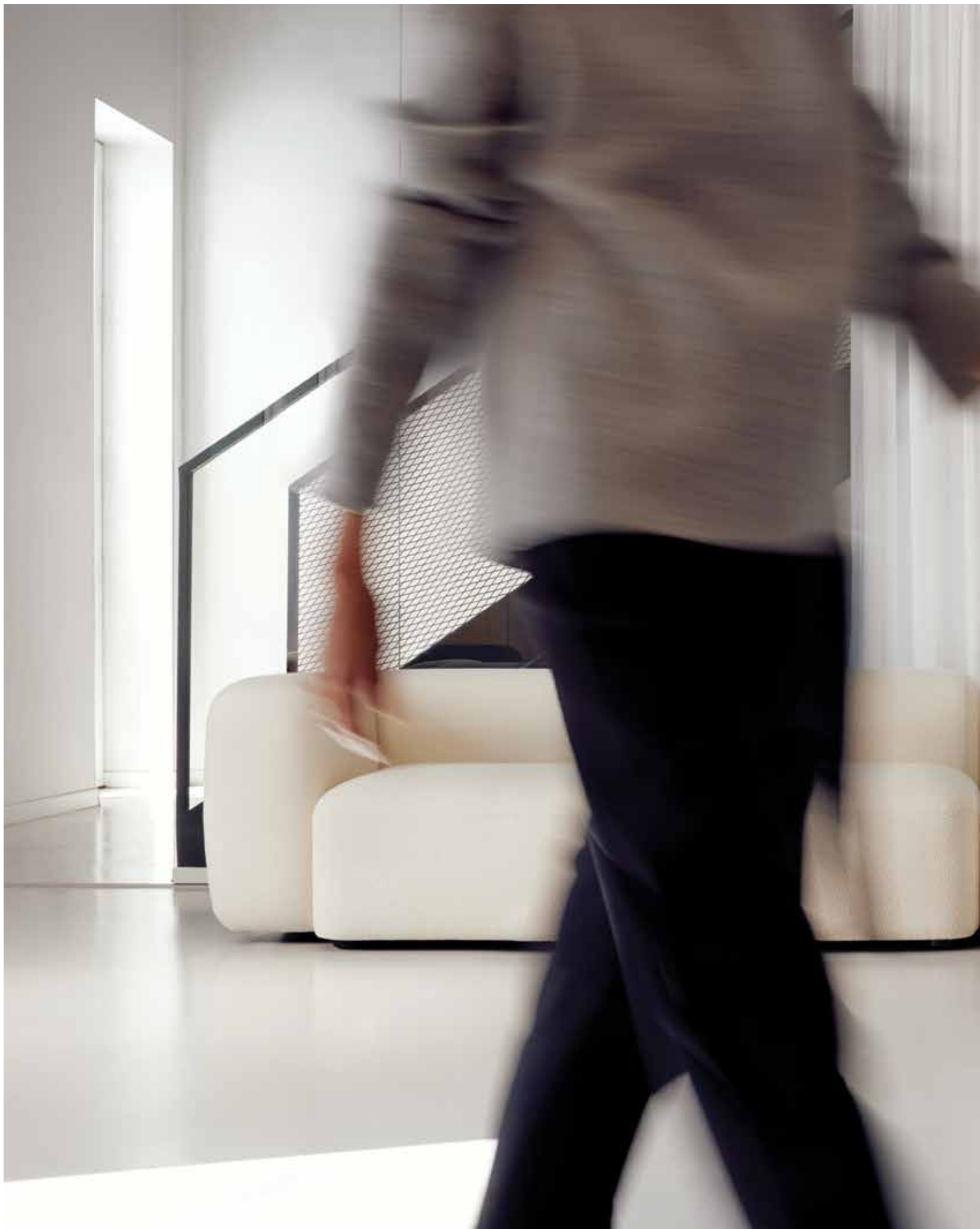

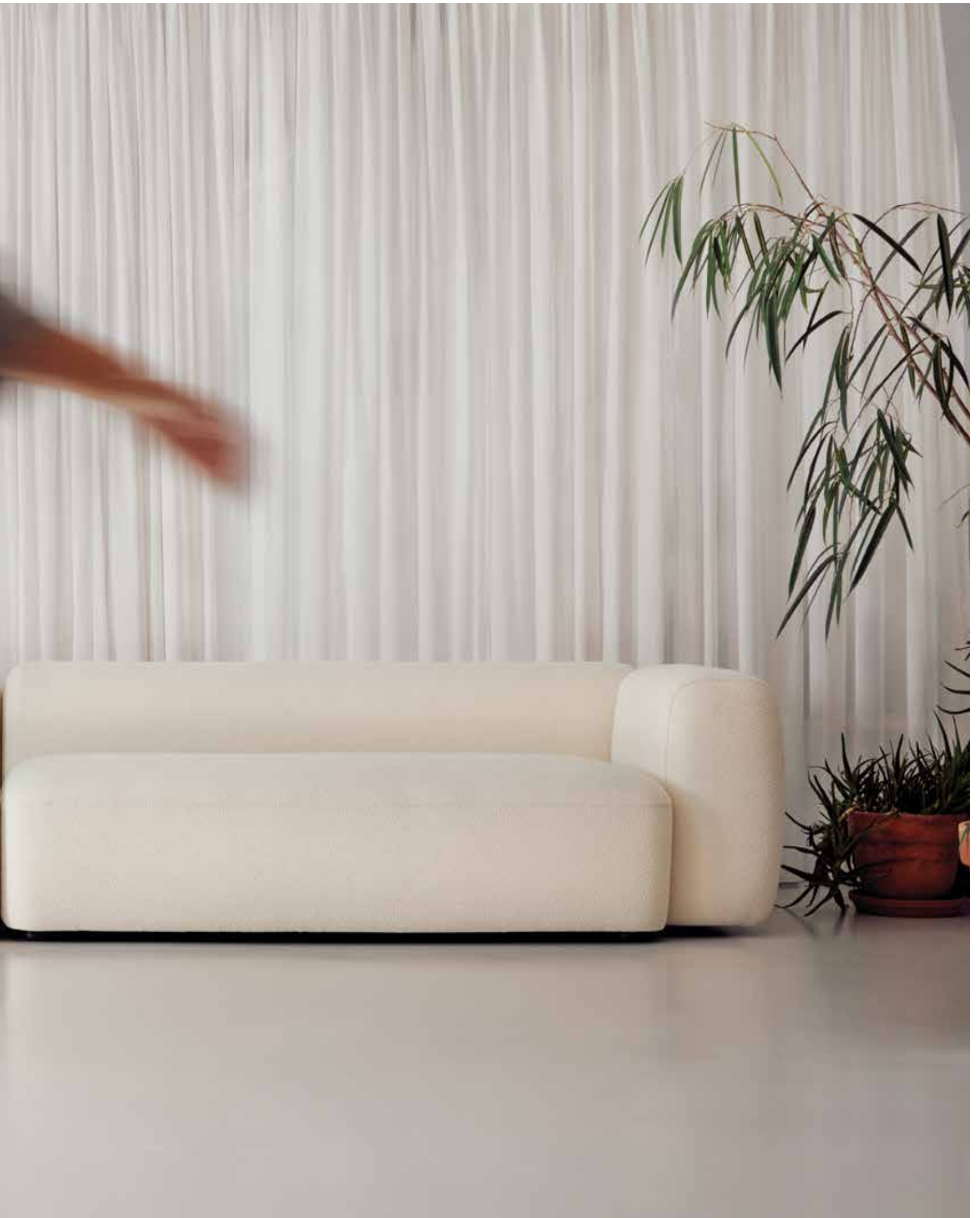





We are proud of our origin, and believe that longevity requires deep roots and solid support. We place a great deal of importance on our carbon footprint impact. The resources we use are found in our immediate vicinity, and we thus have a direct impact on decreasing hazardous emission and the effect it has on the environment. Most of the materials are sourced locally and complemented with the highest quality international upholstery fabrics.

We perceive circular economy as a standard that we never fall short of. We pay attention to our zero waste policy, as we process all our waste into heating resources. We have high awareness of design, modern times and contemporary man. This awareness involves engineering of the interactions between persons and objects and care for the people who would use our furniture daily. We therefore pay attention to ergonomics and proportions, details, manufacturing, materials

and accessibility of our products. Whenever we look around, some questions emerge: what good design and what functional design is, how quality can be maintained, what the needs of modern people are, what is considered beautiful today, what is always considered beautiful, how to make furniture that would endure... Volumen is the story we created in response to all these questions. And perhaps the most important of all – Volumen is daily care for people and their needs.





01	Dolmen	18-51
02	Monolite	52-69
03	Le Mans	70-87
04	Mandarin	88-103
05	Tribeca	104-135
06	Kubik	136-153

07	Panama	154-165
08	Cabrio	166-171
09	Mono	172-179
10	Hippo	180-187
11	Aspen	188-200
	Product Sheets	201-221



U Upholstery
A Armrest
L Legs
B Rotating Base

Vol.

01

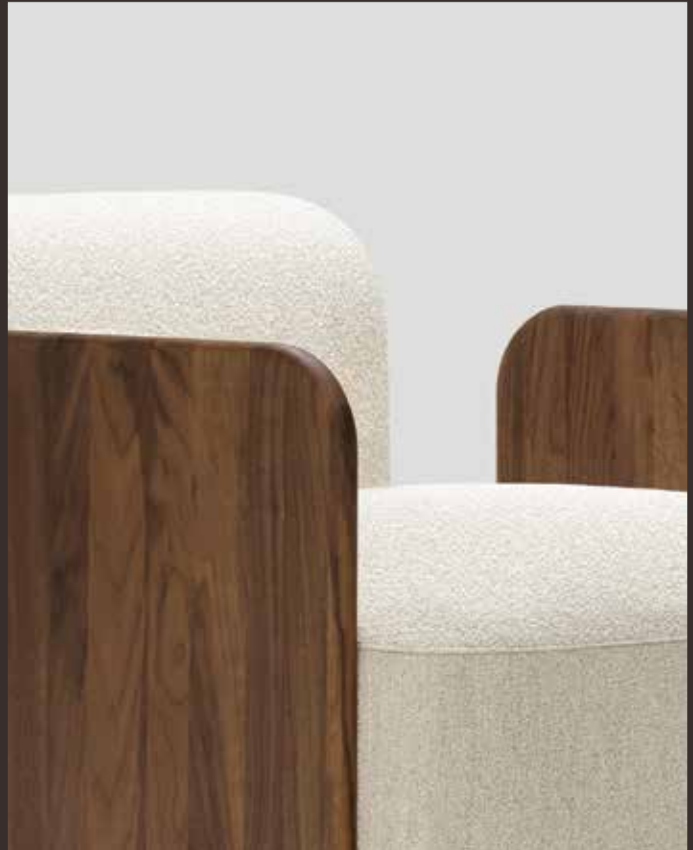

Sofas
Armchairs
Poufs

DESIGN BY
Zoran Jedrejčić

Dolmen

Dolmen is a collection of modernist design in the best sense of the word, with contours that are sculptural and reduced to geometrical shapes. Its harmonious lines can easily fit each individual space, or taste. The elements of this system that are readily connectable in all directions, enable creation of an infinite number of spatial compositions, equally functional in either private, or public spaces. Rotation of the elements can also result in private zones that facilitate users' interaction. Modularity of the collection is perfectly combined with comfort, making Dolmen an epitome of highly functional furniture. The collection is designed as a harmonious and measured interplay of straight and rounded lines, where every piece brings comfort, even visually. With its optional armrests made of solid oak or walnut, Dolmen introduces warmth into your home, but is also excellent in large offices, hotel lobbies, airport lounge areas, and other public spaces.

DO11, DO13, DO97, DO12,
DO13, DO13, DO97, DO67
U Orsetto 01/2
A American Walnut / Natural / Oil
L Solid Wood / Black RAL 9005





DO13, DO13, DO13, DO50
U Orsetto 05/10
L Solid Wood / Black RAL 9005



DO11

U Orsetto 01/1

A Oak / Natural / White Oil

L Solid Wood / Black RAL 9005

**DO12, DO97, DO13,
DO50, DO13, DO13, DO11**

U Orsetto 01/2

A American Walnut / Natural / Oil

L Solid Wood / Black RAL 9005

Dolmen is a modernist sofa-system designed with a measured ratio between straight and curved elements, contours and surfaces. Due to its harmonious design, it easily fits different types of interiors. Dolmen sofa has contours that are sculptural and reduced to geometrical shapes, while the fact that it is easily connectible in all directions, enables creation of an infinite number of spatial compositions, making the Dolmen system great fun. Its modularity enables a high rate of adaptability to different needs and conditions. The optional armrests made of solid oak or walnut add additional warmth to this sofa in either private or public context.



DO97, DO11, DO13, DO13, DO50, DO13, DO13, DO12

U Orsetto 01/1

A American Walnut / Natural / Oil

L Solid Wood / Black RAL 9005





Combinations

Proposal 19L
see pg. 203

**DO11, DO13, DO13, DO50,
DO13, DO13, DO12, DO97**
U Orsetto 01/2
A American Walnut / Natural / Oil
L Solid Wood / Black RAL 9005

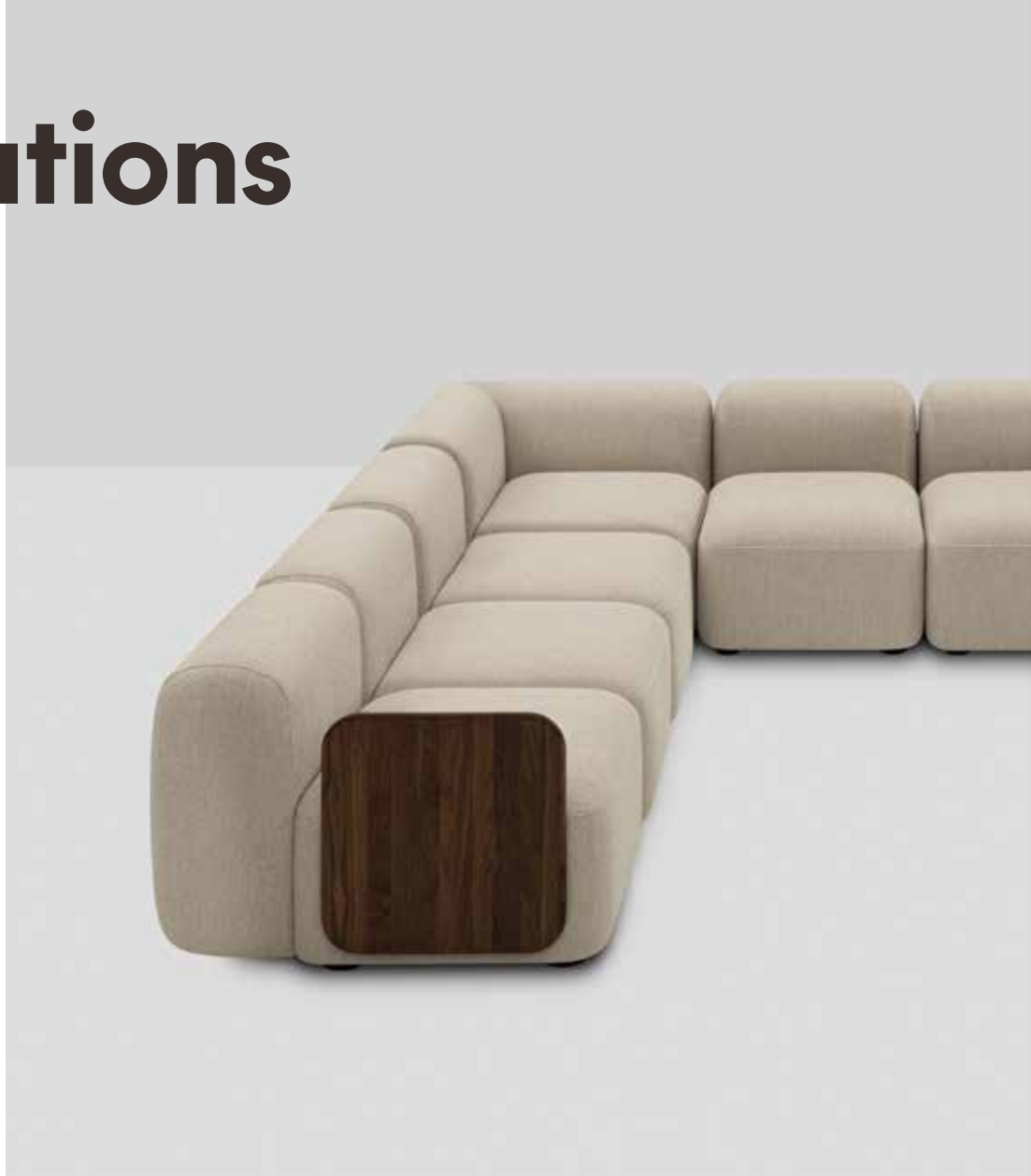



DO11, DO11

U Orsetto 01/2

A American Walnut / Natural / Oil

L Solid Wood / Black RAL 9005



Proposal 04
see pg. 203

DO11, DO13, DO12

U Orsetto 01/2

A American Walnut / Natural / Oil

L Solid Wood / Black RAL 9005





**DO13, DO13, DO50,
DO13, DO97, DO12**
U Orsetto 01/1
A American Walnut / Natural / Oil
L Solid Wood / Black RAL 9005

**DO14, DO14, DO13,
DO13, DO15, DO15**
U Orsetto 01/2
L Solid Wood / Black RAL 9005

**DO15, DO15, DO13,
DO13, DO14, DO14**
U Orsetto 05/10
L Solid Wood / Black RAL 9005







DO50, DO13, DO13
U Orsetto 01/1
L Solid Wood / Black RAL 9005

DO15, DO15
U Orsetto 05/10
L Solid Wood / Black RAL 9005

DO15, DO15, DO13,
DO13, DO50
U Orsetto 01/2
L Solid Wood / Black RAL 9005





**DO50, DO13, DO13,
DO15, DO15**
U Orsetto 01/2
L Solid Wood / Black RAL 9005

**DO15, DO15, DO13,
DO13, DO50**
U Orsetto 05/10
L Solid Wood / Black RAL 9005



Combinations

Proposal 41
see pg. 205

Proposal 44
see pg. 205

DO15, DO15, DO14, DO14
U Orsetto 01/2
L Solid Wood / Black RAL 9005

DO15, DO15, DO14, DO14
U Orsetto 05/10
L Solid Wood / Black RAL 9005

DO13, DO15, DO14,
DO14, DO15
U Orsetto 01/2
L Solid Wood / Black RAL 9005

DO15, DO14, DO14,
DO15, DO13
U Orsetto 05/10
L Solid Wood / Black RAL 9005





**DO14, DO14, DO13,
DO13, DO13, DO112, DO112**
U Orsetto 01/2
L Solid Wood / Black RAL 9005

**DO14, DO14, DO13,
DO13, DO13, DO112, DO112**
U Orsetto 05/10
L Solid Wood / Black RAL 9005



DO11, DO67, DO13

U Orsetto 01/2

A American Walnut / Natural / Oil

L Solid Wood / Black RAL 9005





Combinations

**DO50, DO13, DO13,
DO13, DO67, DO50**
U Orsetto 01/2
L Solid Wood / Black RAL 9005





**DO11, DO97, DO97,
DO11, DO67, DO13**
U Orsetto 01/2
A American Walnut / Natural / Oil
L Solid Wood / Black RAL 9005



DO11, DO97, DO97, DO11
U Orsetto 01/2
A American Walnut / Natural / Oil
L Solid Wood / Black RAL 9005

DO50, DO13, DO13

U Orsetto 05/10

L Solid Wood / Black RAL 9005

DO97

U Orsetto 01/1

L Solid Wood / Black RAL 9005



DO13, DO13, DO50
U Orsetto 01/1
L Solid Wood / Black RAL 9005



Combinations



**DO50, DO13, DO13,
DO13, DO50**
U Orsetto 05/10
L Solid Wood / Black RAL 9005

**DO13, DO13, DO13,
DO50, DO97**
U Orsetto 01/2
L Solid Wood / Black RAL 9005





Proposal 27R
see pg. 204

**DO97, DO50, DO13,
DO13, DO50**
U Orsetto 01/2
L Solid Wood / Black RAL 9005

DO11, DO13, DO13, DO13, DO12, DO67
U Orsetto 01/2
A Oak / Natural / White Oil
L Solid Wood / Black RAL 9005



**DO10****U** Orsetto 01/1**A** American Walnut / Natural / Oil**L** Solid Wood / Black RAL 9005**DO10****U** Orsetto 01/1**A** Oak / Natural / White Oil**L** Solid Wood / Black RAL 9005

Dolmen armchair is an individual piece, incorporating all the characteristics of the entire collection. Its harmonious lines can easily fit your personalized interior. The measured ratio between straight and curved lines makes the armchair visually comfortable and elegant. Either as a supplement to the sofa-system, or as an individual piece of furniture, the Dolmen armchair, with its striking appearance, introduces warmth and dynamics into any interior. The armchair and sofa can additionally be complemented with Dolmen pouf, as the collection offers practically endless number of different combinations.





DO10

U Orsetto 01/1

A Oak / Natural / White Oil

L Solid Wood / Black RAL 9005



Combinations

**DO50, DO13, DO13, DO14,
DO14, DO13, DO13, DO50**
U Orsetto 01/2
L Solid Wood / Black RAL 9005





**DO11, DO13, DO13,
DO15, DO13, DO13, DO12**
U Orsetto 01/2
A Oak / Natural / White Oil
L Solid Wood / Black RAL 9005

Proposal 40L
see pg. 205

**DO50, DO13, DO13, DO13,
DO97, DO13, DO13, DO50,**
U Orsetto 01/2
L Solid Wood / Black RAL 9005



VOLUMEN

MO25

U Rico 989.510

L Solid Wood / Black RAL 9005

02



Sofas
Armchairs
Poufs

DESIGN BY
Zoran Jedrejčić

Monolite

Monolite collection is striking and iconic, lending character to any space, its design relying on the contrast between its visual massiveness and the exquisite comfort and softness. The look of the collection is clearly evoked by its name – these are sturdy, compact and stable pieces of furniture, the presence of which would not stay unnoticed in any location. Monolite easily fits different spaces and immediately becomes the pillar of the interior. These are visually monolithic pieces of extreme comfort, making Monolite an excellent choice for both private and public contexts. In addition to various combinations, Monolite offers the options of two-seat and three-seat sofa, armchair and pouf.

MO30

U Main Line Flax 19

L Solid Wood / Black RAL 9005







MONOLITE

MO30**U** Main Line Flax 19**L** Solid Wood / Black RAL 9005

Monolite sofa is a versatile piece of furniture suitable for any interior. This is a striking piece of furniture, with the design based on the contrast between its visual sturdiness and the exquisite comfort and softness that it offers. Monolite is a robust, compact and stable sofa, with the name inspired by the immense force it exudes – it is a versatile piece of furniture that lends character to any space that accommodates it. The superior comfort of this sofa makes it the ideal choice for either private, or public spaces.

MO25

U Rico 989.510

L Solid Wood / Black RAL 9005





MO10**U** Mazurka II**L** Solid Wood / Black RAL 9005

Monolite is an armchair with character, whose design is directly described by its name. This is a compact, stable and visually monolithic piece, the presence of which cannot stay unnoticed in any interior. The Monolite armchair is extremely comfortable and it easily fits any interior, simultaneously lending it character. It is an excellent choice for private and public spaces. The armchair can serve as a complement to the sofa, but also as a perfect individual piece. It creates specific dynamics when combined with the pouf.





MO10

U Main Line Flax 19
L Solid Wood / Black RAL 9005

MO30

U Main Line Flax 19
L Solid Wood / Black RAL 9005

MO45

U Main Line Flax 17
L Solid Wood / Black RAL 9005



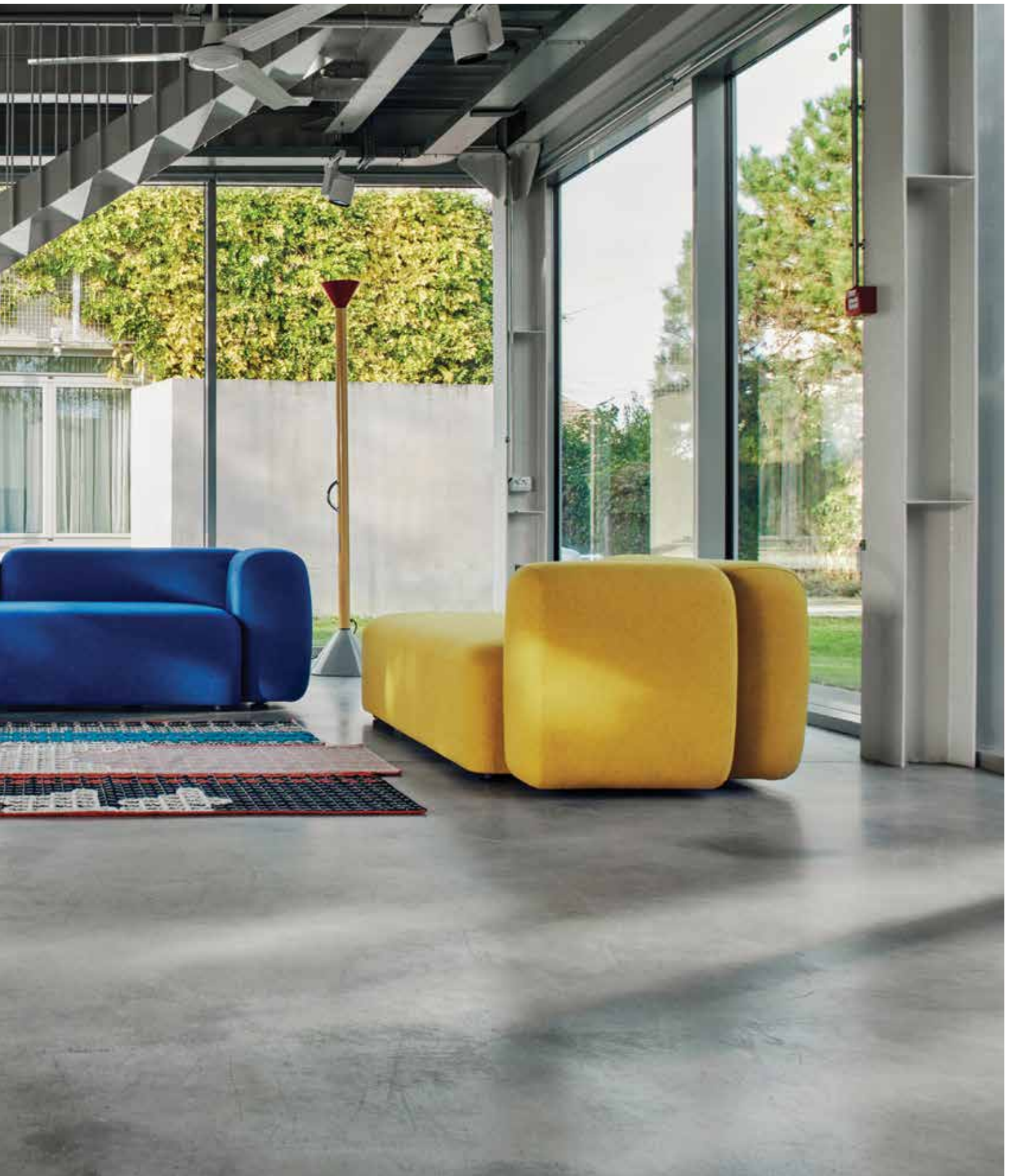

Proposal 08L
see pg. 207

MO40, MO43

U Mazurka 01

L Solid Wood / Black RAL 9005







Proposal 07
see pg. 207

MO26, MO27
U Mazurka 01
L Solid Wood / Black RAL 9005



03



Sofas
Armchairs
Poufs

DESIGN BY
Zoran Jedrejčić

Le Mans

Le Mans is an elegant collection of classical lines and accentuated form – sophisticated and impeccable. The sculptural contours of this system, together with its comfortable backs and armrests make Le Mans collection compact and highly cozy. The oval shape of the system adds to its all-around harmonious appearance. The armrests are rounded for ergonomics and aesthetics, making the entire Le Mans collection a pursuit of perfect proportions. In addition to various combinations, Le Mans offers the options of two-seat and three-seat sofa, armchair and pouf. The collection is intended for both private and public spaces.

LM30

U Yoredale 17

L Metal / Black RAL 9005 / Wooden Tap





LM30**U** Yoredale 17**L** Metal / Black RAL 9005 / Wooden Tap**LM30****U** Orsetto 01/1**L** Metal / Black RAL 9005 / Wooden Tap

Le Mans sofa is a refined piece of classical lines. Its oval shape incorporates the harmonious proportion between its impeccable volume and comfortable back and armrests. The ergonomics and aesthetics of the Le Mans sofa are the embodiment of the search for perfect proportions. This is a highly comfortable and compact sofa intended for private and public spaces.





LM10, LM30

U Orsetto 01/1

L Metal / Black RAL 9005 / Wooden Tap



LM30

U Orsetto 01/1

L Metal / Black RAL 9005 / Wooden Tap



LE MANS

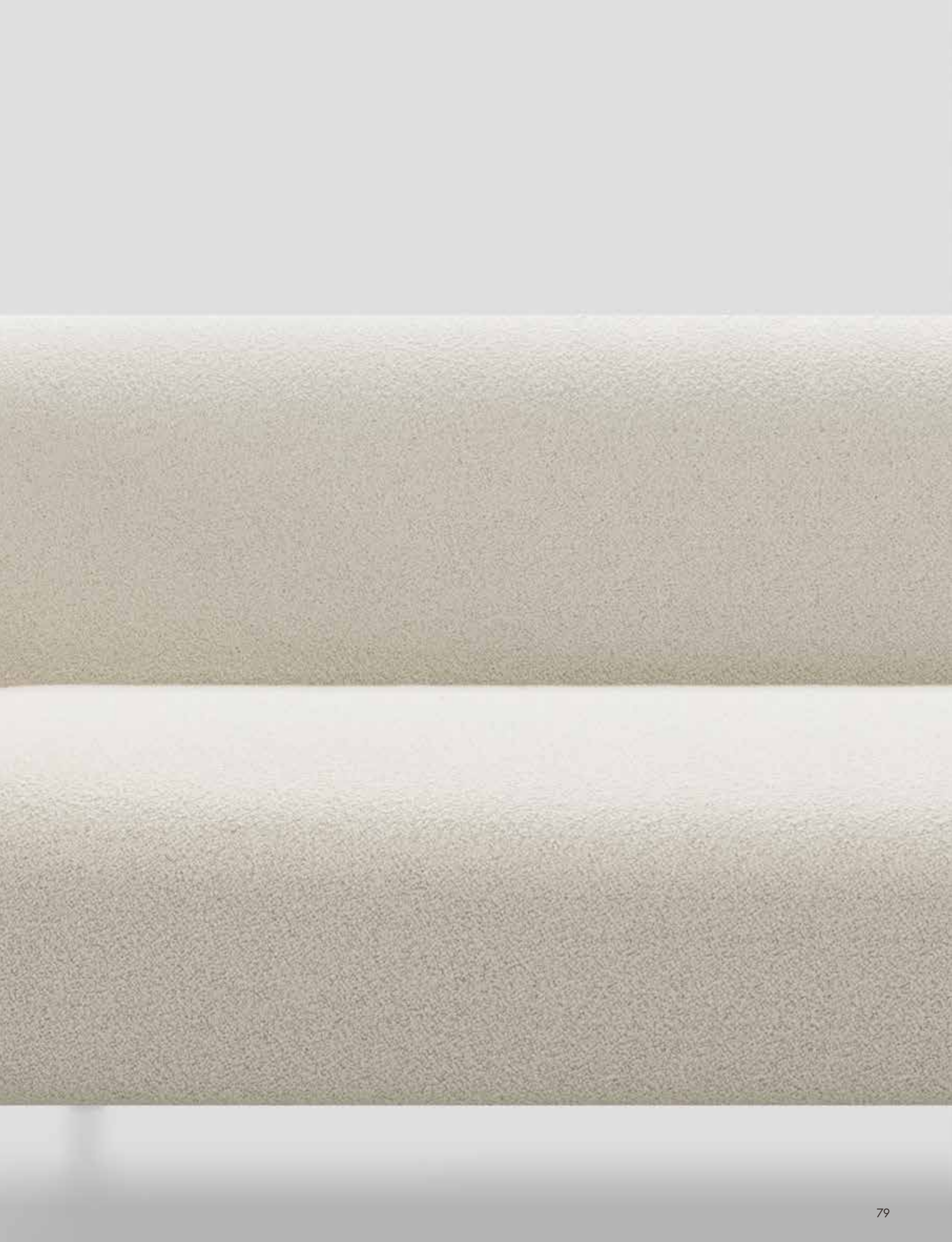

LM10**U** Yoredale 19**L** Metal / Black RAL 9005 / Wooden Tap

Le Mans is an elegant and sophisticated armchair, functioning perfectly as an independent piece. This extremely comfortable chair strikes the perfect balance between aesthetics and ergonomics. Its oval shape fits beautifully in every interior. The sculptural volume of the armchair involves comfy back and armrests. Combined with the pouf, Le Mans acquires regal appearance.



Proposal 05L
see pg. 209

LM26, LM43
U Rico 989.490
L Metal / Black RAL 9005 / Wooden Tap







LM80

U Rico 989.490

L Metal / Black RAL 9005 / Wooden Tap





Proposal 04
see pg. 209

LM26, LM27

U Rico 989.490

L Metal / Black RAL 9005 / Wooden Tap



H

04



Sofas
Poufs

DESIGN BY
Zoran Jedrejčić

Mandarin

Mandarin collection combines comfort with carefully constructed form. The design is specific and discretely eastern. Curved at a side, Mandarin visually levitates. The oversize rotund wooden legs made of oak or walnut lend the collection a particular rhythm and dynamics. The sculpted arcs are pleasing to the eye, making Mandarin an excellent option for any private or public context. In addition to various combinations, the collection includes two-seat and three-seat sofa, and pouf.

MA30**U** Orsetto 01/1**L** American Walnut / Natural / Oil**MA30****U** Orsetto 01/1**L** Oak / Natural / White Oil

Mandarin is an unconventional sofa of discrete design – comfortable and pleasing to the eye. The Mandarin sofa's volume is supported by the oversize rotund legs, creating a subtle and unassuming rhythm which makes this sofa attractive. The sofa can be complemented with the pouf, to provide superior comfort and complete the combination.



MA25

U Main Line Flax 17

L Oak / Natural / White Oil







MA30

U Orsetto 01/1

L Oak / Natural / White Oil



MA45

U Mazurka 11

L Oak / Natural / White Oil





Proposal 05L
see pg. 211

MA26, MA43
U Yoredale 04
L Oak / Natural / White Oil









MA80
U Yoredale 04
L Oak / Natural / White Oil

MA25
U Orsetto 01/1
L Oak / Natural / White Oil



Proposal 04
see pg. 211

MA26, MA27
U Yoredale 04
L Oak / Natural / White Oil



2

H

05



Sofas
Armchairs
Poufs

DESIGN BY
Zoran Jedrejčić

Tribeca

Tribeca is a modular and flexible collection of emphasized dimensions, intended for spacious interiors. Big feather-filled cushions add to the comfort of this collection's pieces. The elements of this system that are readily connectable in all directions, enable creation of an infinite number of spatial compositions, equally functional in either private or public contexts. The dynamic visual rhythm of the pieces' backside accentuates Tribeca's design. The exaggerated size and geometric arcs are designed as flexible and separate structures, making Tribeca a sitting arrangement capable of reshaping the new complexity of the modern living marked by excessive planning.

**TR42, TR13, TR13,
TR102, TR13, TR12**
U Rico 989.080
L Solid Wood / Black RAL 9005





TR13**U** Rico 989.080**L** Solid Wood / Black RAL 9005

Tribeca is in a sense a typical massive sofa, perfect for large interiors. Its accentuated dimensions, modularity and flexibility are matched only with the superior comfort of its feather-filled cushions. The elements of the Tribeca sofa-system are readily and easily connected, enabling the creation of a large number of different spatial combinations. Its characteristics make this sofa the perfect option for spacious private and public areas. Pouf is made to complement the sofa and create with it a compact unit.



Proposal 47
see pg. 215

TR11, TR12

U Rico 989.080

L Solid Wood / Black RAL 9005







**TR11, TR13, TR102,
TR13, TR13, TR12**
U Rico 989.080
L Solid Wood / Black RAL 9005



Combinations

**TR102, TR11, TR13,
TR13, TR12**

U Rico 989.080

L Solid Wood / Black RAL 9005





TR11, TR13, TR13, TR102
U Rico 989.080
L Solid Wood / Black RAL 9005



**TR11, TR13, TR13,
TR102, TR13, TR12**
U Rico 989.080
L Solid Wood / Black RAL 9005



TR30, TR60 Table, TR31, TR40
U Boemian 624.050
T Black Glass
L Solid Wood / Black RAL 9005





Proposal 17L
see pg. 214

TR40, TR33, TR43

U Boemian 624.050

L Solid Wood / Black RAL 9005





Proposal 40L
see pg. 215

TR40, TR33, TR31, TR32
U Boemian 624.050
L Solid Wood / Black RAL 9005





TR102
U Boemian 624.050
L Solid Wood / Black RAL 9005





TR30
U Boemian 624.050
L Solid Wood / Black RAL 9005

Proposal 42L
see pg. 215

TR31, TR102, TR33, TR43
U Boemian 624.050
L Solid Wood / Black RAL 9005





Proposal 24L
see pg. 214

TR60 Table, TR33, TR30

U Boemian 624.050

T Black Glass

L Solid Wood / Black RAL 9005







TR60 Table

U Boemian 624.050

T Black Glass

L Solid Wood / Black RAL 9005

TR30

U Boemian 624.050

L Solid Wood / Black RAL 9005





TR30, TR33, TR102, TR43

U Boemian 624.050
L Solid Wood / Black RAL 9005

TR60 Table

U Boemian 624.050
T Black Glass
L Solid Wood / Black RAL 9005



Combinations

Proposal 42L
see pg. 215

TR31, TR102, TR33, TR43
U Boemian 624.050
L Solid Wood / Black RAL 9005





Proposal 25L
see pg. 214

TR102, TR33, TR30
U Boemian 624.050
L Solid Wood / Black RAL 9005



Proposal 26R
see pg. 214

TR30, TR33, TR41
U Boemian 624.050
L Solid Wood / Black RAL 9005



Proposal 17L
see pg. 214

TR40, TR33, TR43
U Boemian 624.050
L Solid Wood / Black RAL 9005



VOLUMEN

KU30

U Main Line Flax 19

L Oak / Natural / White Oil

06



Sofas
Armchairs
Poufs

DESIGN BY
Zoran Jedrejčić

Kubik

Kubik is a collection of emphasized geometrics and rectangular forms. The design involves a contrast between the firm contours and the soft, comfy sitting arrangement, propped on slender metal or wooden legs. The harmonious interplay between the reliable visual geometry and the fluffy comfort, create two distinct impressions – Kubik is simultaneously sturdy and delicate. The specific visual rhythm created by the shifts between fullness and emptiness, lends this collection its particular continuity and dynamics. Kubik is a modular collection involving feather-filled cushions, deep sitting, exquisite comfort and extreme stability and sturdiness. It is intended for both public and private spaces. Kubik legs come in either metal or wood – walnut or oak in natural or black color.

KU25

U Rico 989.510

L Oak / Natural / White Oil







KU30**U** Main Line Flax 19**L** Metal / Black RAL 9005 / Wooden Tap

Kubik is a compact, stable and comfortable sofa of a particular visual rhythm. Its shape is rectangular, while the design represents an interplay between the firm angularity and the fluffy comfort. This makes Kubik sofa appear both firm and soft. The discrete dynamics is contributed by slender legs. This is a deep-sitting sofa of superior comfort, with feather-filled cushions. Kubik is simultaneously a typical and specific sofa which fits excellently into different types of interiors. The sofa can be complemented with the pouf, to leave the impression of a more complete whole and additionally promote comfort.

KU30

U Main Line Flax 19

L Metal / Black RAL 9005 / Wooden Tap





KU80, KU30

U Main Line Flax 19

L Oak / Natural / White Oil





Proposal 09L
see pg. 217

KU40, KU43

U Boemian 624.000

L Oak / Natural / White Oil







Proposal 06L
see pg. 217

KU31, KU43
U Boemian 624.000
L Oak / Natural / White Oil



Proposal 07
see pg. 217

KU31, KU32

U Boemian 624.000

L Oak / Natural / White Oil





Proposal 07
see pg. 217

KU31, KU32

U Boemian 624.000

L Oak / Natural / White Oil





07

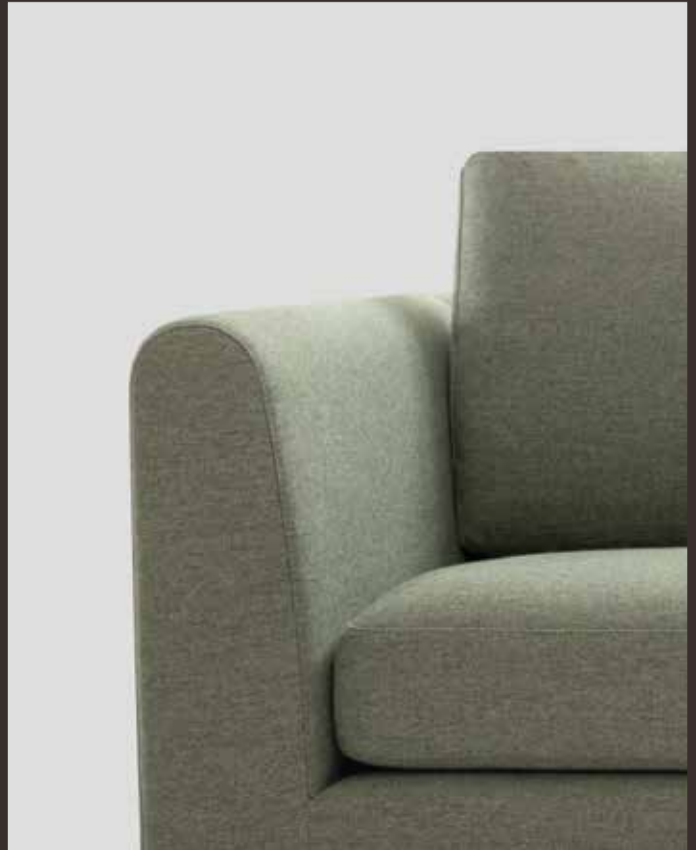

Sofas
Poufs

DESIGN BY
Zoran Jedrejčić

Panama

Panama is a classical collection, inspired by colonial style, of understated design causing the pieces to appear very light in any space, and thus making it a perfect option for any business or public area. This collection of archetypal simplicity is extremely comfortable, due to its feather-filled cushions. The design involves a contrast created when these massive pieces of firm contours, are propped on slender metal legs. The Panama collection is unassuming and suitable for all types of spaces and interiors, and its great sturdiness make it the perfect contract furniture.



PA30

U Orsetto 01/1

L Metal / Black RAL 9005 / Wooden Tap



Panama is an embodiment of the idea of a sofa. It is archetypically simple and subtle. In private spaces it appears unobtrusive and easily fits different settings. Providing that it is not visually demanding, it is also perfect for business and public environments. Panama is a highly comfortable sofa of perfect volume. This reliable sofa can be complemented with the pouf which offers promoted comfort and can serve as an independent seat, while also representing an optimal visual complement to the sofa.

PA25

U Rico 989.150

L Metal / Black RAL 9005 / Wooden Tap





PA30

U Orsetto 01/1

L Metal / Black RAL 9005 / Wooden Tap



Proposal 04L
see pg. 219

PA26, PA43

U Main Line Flax 57

L Metal / Black RAL 9005 / Wooden Tap





PA80

U Main Line Flax 57

L Metal / Black RAL 9005 / Wooden Tap



08



Armchairs

DESIGN BY
Zoran Jedrejčić

Cabrio

Cabrio is a compact armchair of superior comfort. Its characteristic wooden legs made of oak or walnut and their insertion into the soft part of the armchair, emphasize the design which is conceived as a play of simple geometrical forms. Cabrio is a chic armchair that will serve as a beautiful accent in your interior. Due to its dimensions, comfort and characteristic design, Cabrio fits perfectly into different interiors.

CA10
U Orsetto 01/1
L Oak / Natural / White Oil







CA10
U Orsetto 01/1
L Oak / Natural / White Oil



09



Armchairs

DESIGN BY
Zoran Jedrejčić

Mono

Mono is an armchair of unassuming geometrical and sculptural contours and superior comfort. It is characterized by compact dimensions and a union between the modernist and midcentury design. The back cushion is made additionally soft so as to emphasize the sense of comfort attained by the overall ergonomics. The contrast between the oversized wooden legs and the body of the armchair that they penetrate, creates visual tension which makes this miniature piece of furniture exciting. Mono is a compact occasional chair that is easily combined with other furniture in any interior.

MO10

U Orsetto 09/23

L Oak / Natural / White Oil





MO10

U Orsetto 09/23

L Oak / Natural / White Oil





MO10
U Orsetto 09/23
L Oak / Natural / White Oil



10



Armchairs

DESIGN BY
Zoran Jedrejčić

Hippo

Hippo is a sculptural and comfy rotating armchair of compact dimensions. With its distinct rounded shape, the manner it is rotated and superior comfort, it facilitates interaction between its users and the environment in which the chair is located. Hippo lends a hint of relaxed timeless comfort to your home, yet it still functions excellently in large office areas, hotel rooms and lobbies, or other public spaces where facilitated interaction between users is required.

H110
U Orsetto 05/6
B Solid Wood / Black RAL 9005







H110
U Orsetto 05/6
B Solid Wood / Black RAL 9005





H110
U Orsetto 05/6
B Solid Wood / Black RAL 9005



11



Armchairs
Poufs

DESIGN BY
Zoran Jedrejčić

Aspen

Aspen is a sculptural and extremely comfortable rotating armchair. Its round forms and the manner in which the chair is rotated facilitate interaction between its users and the environment in which it is located. It is characterized by the distinct geometrical form, visual comfort and compact dimensions. You can choose from the two models of armchair back, one geometrical, restrained, soft and of clean contours, and the other more puffy, with ornamental stitches that lend it the bold effect. Aspen infuses your home with a hint of glamour, yet it still functions excellently in large office areas, hotel rooms and lobbies, or other public spaces where facilitated interaction between users is required. The armchair is complemented with the corresponding pouf, which can be used either in combination with the chair, or independently. The pouf is also rotatable.

ASIO
U Orsetto 09/23
B Solid Wood / Black RAL 9005







AS10
U Orsetto 09/23
B Solid Wood / Black RAL 9005



AS72

U Orsetto 09/23

B Solid Wood / Black RAL 9005



ASPEN



AS72, AS10

U Orsetto 09/23

B Solid Wood / Black RAL 9005







AS10S
U Rico 989.080
B Solid Wood / Black RAL 9005

AS10S
U Orsetto 01/1
B Solid Wood / Black RAL 9005





AS10, AS72

U Orsetto 09/23

B Solid Wood / Black RAL 9005

01 Dolmen

Elements

Armchair DO10
73×97×65cm

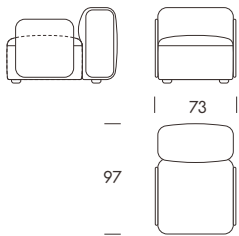

End Unit DO11
70×97×65cm

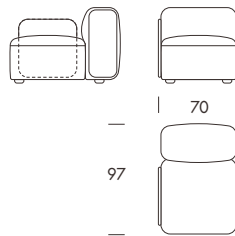

End Unit DO12
70×97×65cm

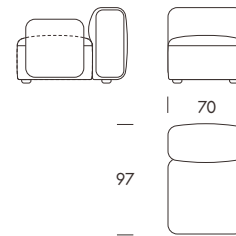

Extension DO13
67×97×65cm

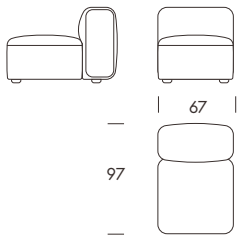

Corner Unit DO50
97×97×65cm

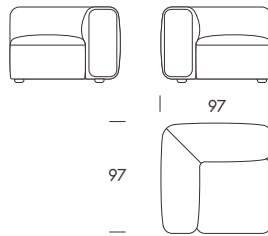

Extension DO15
132×102×65cm

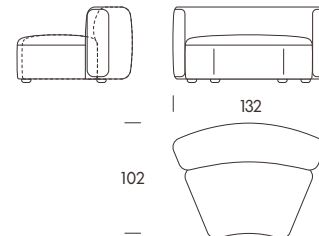

Extension DO14
132×102×65cm

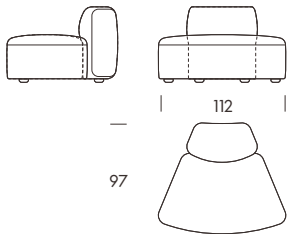

Pouf DO67
67×67×41cm

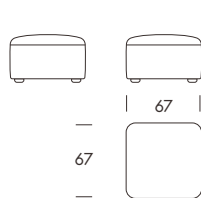

Pouf DO97
97×67×41cm

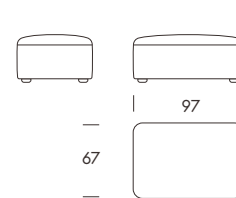

Pouf DO112
112×71×41cm

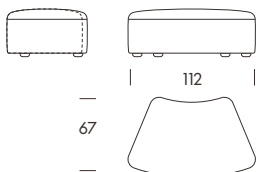

Height 65cm
 Seat Height 41cm
 Seat Depth 64cm

Structure	Solid Wood, Multilayer Plywood
Suspension	Elastic Webbing
Seat & Backrest	Multilayer HR Foam, Polyester Wadding
Legs H 3cm	Solid Wood, included Silicone Pads Black RAL 9005
Upholstery	Fabric
Wooden Armrest	Oak - Natural / White Oil (O/N) Oak - Black RAL 9005 (O/B) American Walnut - Natural (W/N)

Combinations

Proposal 01
DO13

67×97cm



Proposal 02
DO10

73×97cm



Proposal 03
DO11, DO12

140×97cm



Proposal 04
DO11, DO13, DO12

207×97cm



Proposal 05
DO11, DO13, DO13, DO12

274×97cm



Proposal 06L
DO97, DO13, DO13, DO12

Proposal 06R
DO11, DO13, DO13, DO97

271×97cm



Proposal 07L
DO11, DO97, DO13, DO12

Proposal 07R
DO11, DO13, DO97, DO12

274×97cm



Proposal 08L
DO11, DO13, DO13,
DO12, DO67

Proposal 08R
DO67, DO11, DO13,
DO13, DO12

274×164cm

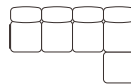

Proposal 09L
DO97, DO13, DO13,
DO13, DO12, DO67

Proposal 09R
DO67, DO11, DO13,
DO13, DO13, DO97

338×164cm

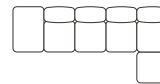

Proposal 10L
DO11, DO13, DO13,
DO15, DO97

Proposal 10R
DO97, DO15, DO13,
DO13, DO12

374×164cm

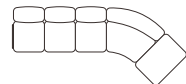

Proposal 11L
DO11, DO13, DO13, DO15,
DO15, DO97

Proposal 11R
DO97, DO15, DO15, DO13,
DO13, DO12

386×246cm

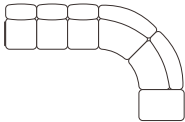

Proposal 12L
DO11, DO13, DO13, DO15,
DO15, DO13, DO12

Proposal 12R
DO11, DO13, DO15, DO15,
DO13, DO13, DO12

386×316cm

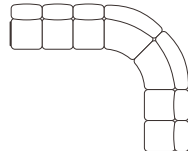

Proposal 13L
DO11, DO13, DO13, DO14,
DO14, DO13, DO12

Proposal 13R
DO11, DO13, DO14, DO14,
DO13, DO13, DO12

360×290cm

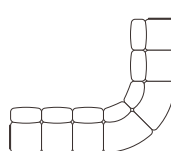

Proposal 14L
DO11, DO13, DO13,
DO14, DO97

Proposal 14R
DO97, DO14, DO13,
DO13, DO12

350×155cm

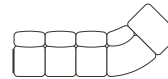

Proposal 15L
DO11, DO13, DO13, DO14,
DO14, DO97

Proposal 15R
DO97, DO14, DO14, DO13,
DO13, DO12

360×220cm

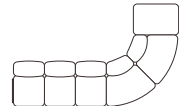

Proposal 16L
DO11, DO13, DO13,
DO15, DO14, DO97

Proposal 16R
DO97, DO14, DO15,
DO13, DO13, DO12

440×168cm

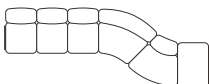

Proposal 17L
DO11, DO13, DO13,
DO50, DO13, DO12

Proposal 17R
DO11, DO13, DO50,
DO13, DO13, DO12

301×234cm

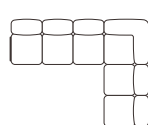

Proposal 18L
DO11, DO13, DO13, DO50,
DO13, DO13, DO97

Proposal 18R
DO97, DO13, DO13, DO50,
DO13, DO13, DO12

301×298cm

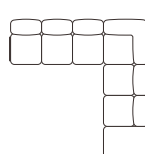

Proposal 19L
DO11, DO13, DO13, DO50,
DO13, DO13, DO12, DO67

Proposal 19R
DO67, DO11, DO13, DO13,
DO50, DO13, DO13, DO12

301×301cm

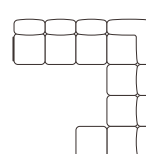

Proposal 20
DO11, DO13, DO50, DO13, DO13,
DO13, DO50, DO13, DO12

395×234cm

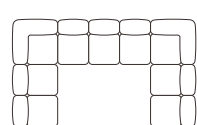

Proposal 21L
DO11, DO13, DO13, DO13,
DO97, DO13, DO13, DO12

Proposal 21R
DO11, DO13, DO13, DO97,
DO13, DO13, DO13, DO12

338×301cm

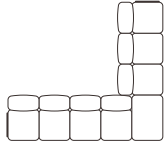

Proposal 22
DO50, DO50

194×97cm



Proposal 23
DO50, DO13, DO50

261×97cm



Proposal 24
DO50, DO13, DO13, DO50

328×97cm

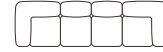

Proposal 25L
DO97, DO13, DO13, DO50

Proposal 25R
DO50, DO13, DO13, DO97

298×97cm



Proposal 26L
DO50, DO97, DO13, DO50

Proposal 26R
DO50, DO13, DO97, DO50

328×97cm



Proposal 27L
DO50, DO13, DO13,
DO50, DO97

Proposal 27R
DO97, DO50, DO13,
DO13, DO50

328×164cm

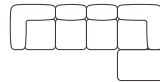

Proposal 28L
DO97, DO13, DO13,
DO13, DO50, DO97

Proposal 28R
DO97, DO50, DO13,
DO13, DO13, DO97

365×164cm

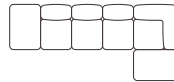

Proposal 29L
DO50, DO13, DO13, DO15,
DO97

Proposal 29R
DO97, DO15, DO13, DO13,
DO50

401×164cm

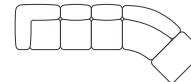

Proposal 30L
DO50, DO13, DO13, DO15,
DO15, DO97

Proposal 30R
DO97, DO15, DO15, DO13,
DO13, DO50

414×246cm

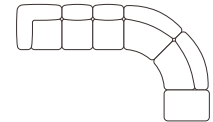

Proposal 31L
DO50, DO13, DO13, DO15,
DO15, DO13, DO50

Proposal 31R
DO50, DO13, DO15, DO15,
DO13, DO13, DO50

414×343cm

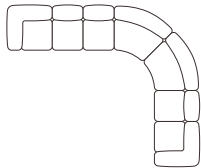

Proposal 32L
DO50, DO13, DO13, DO14,
DO14, DO13, DO50

Proposal 32R
DO50, DO13, DO14, DO14,
DO13, DO13, DO50

387×317cm

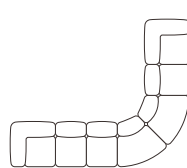

Proposal 33L
DO50, DO13, DO13, DO14,
DO97

Proposal 33R
DO97, DO14, DO13, DO13,
DO50

377×155cm

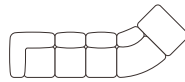

Proposal 34L
DO50, DO13, DO13, DO14,
DO14, DO97

Proposal 34R
DO97, DO14, DO14, DO13,
DO13, DO50

387×220cm

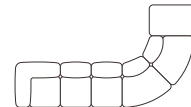

Proposal 35L
DO50, DO13, DO13,
DO15, DO14, DO97

Proposal 35R
DO97, DO14, DO15,
DO13, DO13, DO50

467×168cm

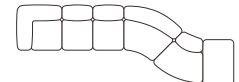

Proposal 36L
DO50, DO13, DO13, DO50,
DO13, DO50

Proposal 36R
DO50, DO13, DO50, DO13,
DO13, DO50

328×261cm

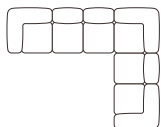

Proposal 37L
DO50, DO13, DO13, DO50,
DO13, DO13, DO97

Proposal 37R
DO97, DO13, DO13, DO50,
DO13, DO13, DO50

328×298cm

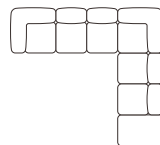

Proposal 38L
DO50, DO13, DO13, DO50,
DO13, DO13, DO50, DO97

Proposal 38R
DO97, DO50, DO13, DO13,
DO50, DO13, DO13, DO50

328×328cm

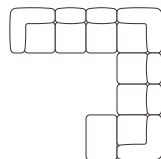

Proposal 39
DO50, DO13, DO50, DO13, DO13,
DO13, DO50, DO13, DO50

395×261cm

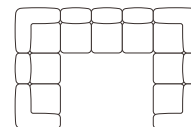

Proposal 40L
DO50, DO13, DO13, DO13,
DO97, DO13, DO13, DO50

Proposal 40R
DO50, DO13, DO13, DO97,
DO13, DO13, DO13, DO50

365×328cm

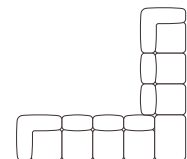

Proposal 41
DO15, DO15, DO15, DO15
360×180m

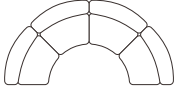

Proposal 42
DO15, DO15, DO13, DO13,
DO15, DO15
494×180m

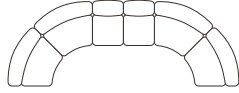

Proposal 43
DO13, DO14, DO15, DO15,
DO14, DO13
474×164m



Proposal 44
DO14, DO14, DO14, DO14
308×154m



Proposal 45
DO14, DO14, DO13, DO13,
DO14, DO14
442×154m

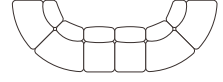

Proposal 46
DO14, DO14, DO15, DO15,
DO14, DO14
548×164m



Proposal 47
DO112, DO112,
DO112, DO112
308×154m



Proposal 48
DO112, DO112, DO67,
DO67, DO112, DO112
434×154m

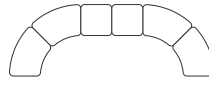

Proposal 49
DO67, DO112, DO112,
DO112, DO112, DO67
474×136m

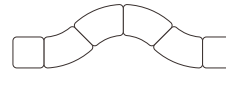

Proposal 50
DO112, DO112, DO112,
DO112, DO112, DO112
548×136m

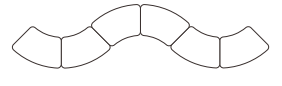

02 Monolite

Elements

Armchair MO10
125×95×65cm

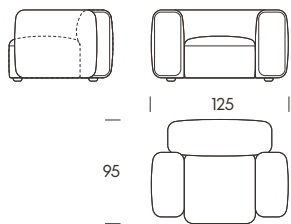

Two Seater Sofa MO25
220×95×65cm

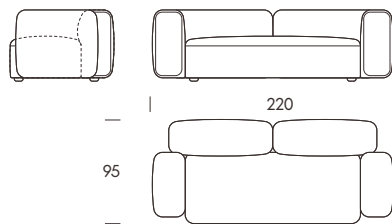

End Unit MO26
190×95×65cm

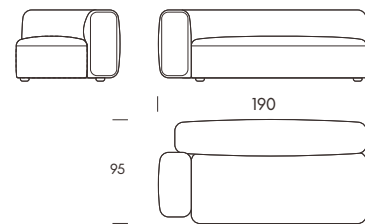

End Unit MO27
190×95×65cm

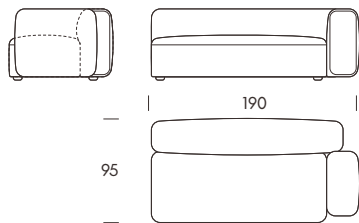

Three Seater Sofa MO30
260×95×65cm

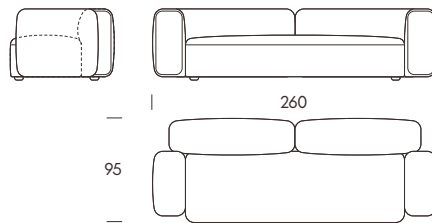

One Seater Extension MO40
160×95×65cm

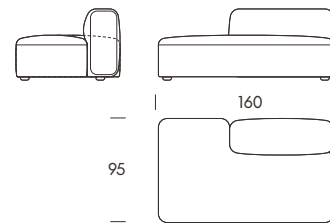

One Seater Extension MO41
160×95×65cm

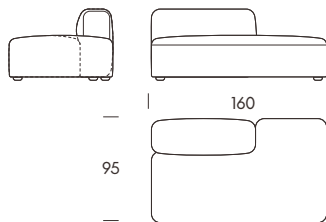

Chaise Longue MO42
110×180×65cm

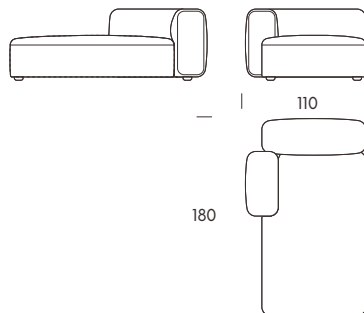

Chaise Longue MO43
110×180×65cm

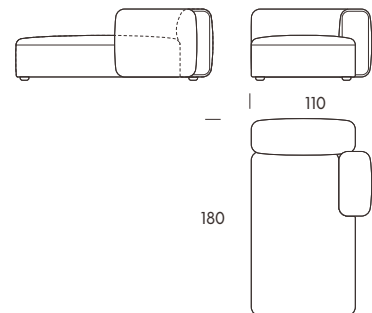

One Seater MO44
190×95×65cm

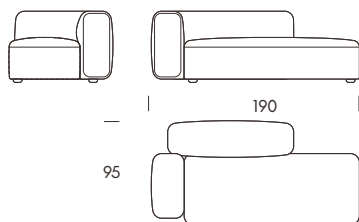

One Seater MO45
190×95×65cm

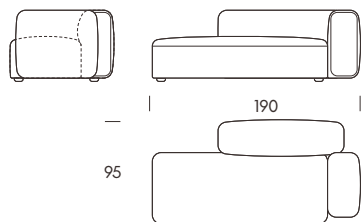

Pouf MO80
80×65×41cm

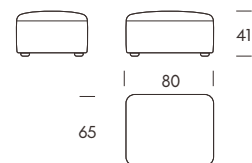

Height 65cm
Seat Height 41cm
Seat Depth 64cm

Structure	Solid Wood, Multilayer Plywood
Suspension	Elastic Webbing
Seat & Backrest	Multilayer HR Foam, Polyester Wadding
Legs H 3cm	Solid Wood, included Silicone Pads Black RAL 9005
Upholstery	Fabric

Combinations

Proposal 01
MO10

125×95cm



Proposal 02L
MO44

Proposal 02R
MO45

190×95cm



Proposal 03
MO25

220×95cm



Proposal 04
MO30

260×95cm



Proposal 05L
MO26, MO41

Proposal 05R
MO40, MO27

350×95cm



Proposal 06L
MO26, MO43

Proposal 06R
MO42, MO27

300×180cm

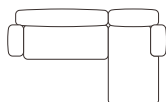

Proposal 07
MO26, MO27

380×95cm



Proposal 08L
MO40, MO43

Proposal 08R
MO42, MO41

270×180cm

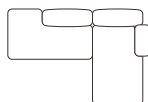

03 Le Mans

Elements

Armchair LM10
100×76.5×67cm

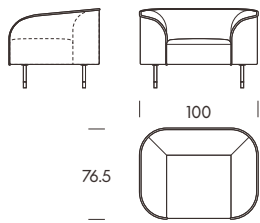

Two Seater Sofa LM25
210×85×72cm

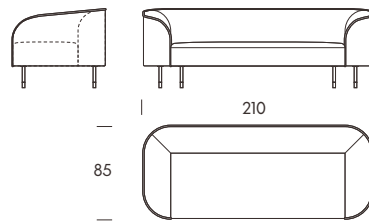

End Unit LM26
185×85×72cm

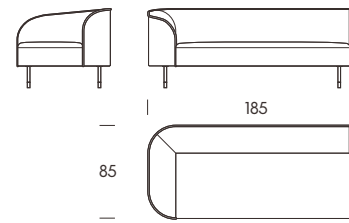

End Unit LM27
185×85×72cm

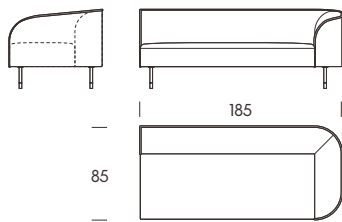

Three Seater Sofa LM30
250×85×72cm

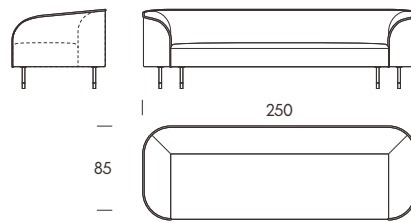

Chaise Longue LM42
105×165×72cm

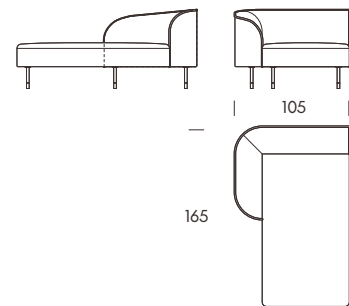

Chaise Longue LM43
105×165×72cm

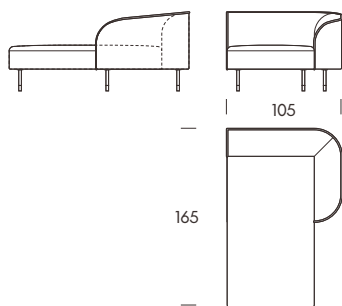

Pouf LM80
80×60×42cm

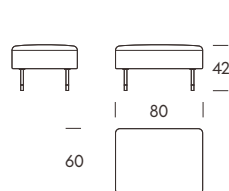

Height 72cm
Seat Height 42cm
Seat Depth 60cm

Structure Solid Wood, Multilayer Plywood

Suspension Elastic Webbing

Seat & Backrest Multilayer HR Foam,
Polyester Wadding

Legs H 20cm Metal, included Silicone Pads
Metal - Black RAL 9005 - ø25mm
+ Wooden Tap ø25mm, (M/B)

Upholstery Fabric

Combinations

Proposal 01
LM10

100×76.5cm



Proposal 02
LM25

210×85cm



Proposal 03
LM30

250×85cm



Proposal 04
LM26, LM27

370×85cm



Proposal 05L
LM26, LM43

Proposal 05R
LM42, LM27

290×165cm

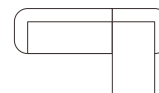

04 Mandarin

Elements

Two Seater Sofa MA25
216×88×70cm

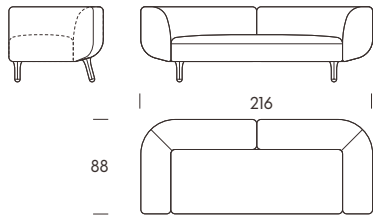

End Unit MA26
188×88×70cm

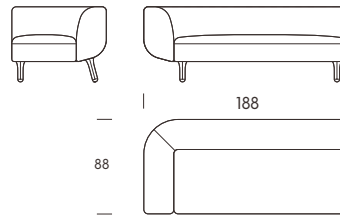

End Unit MA27
188×88×70cm

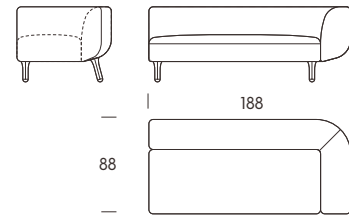

Three Seater Sofa MA30
256×88×70cm

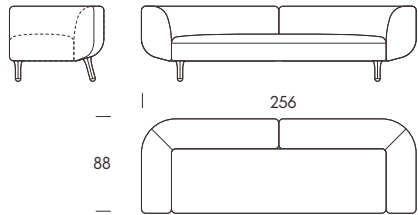

Chaise Longue MA42
108×168×70cm

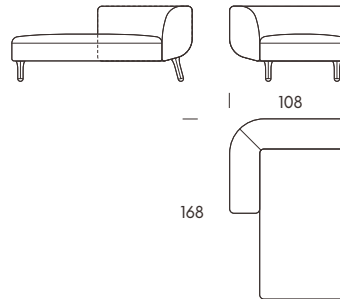

Chaise Longue MA43
108×168×70cm

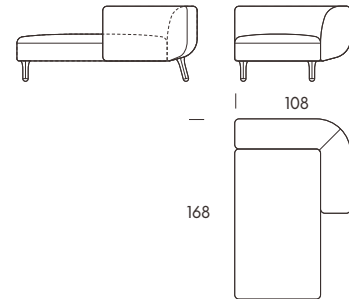

One Seater MA44
168×88×70cm

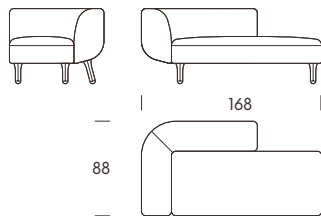

One Seater MA45
168×88×70cm

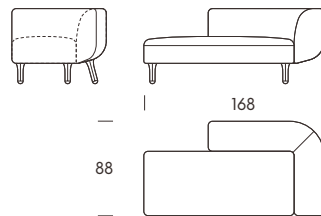

Pouf MA80
80×60×44cm

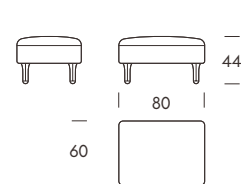

Height
Seat Height
Seat Depth

70cm
44cm
60cm

Structure

Solid Wood, Multilayer Plywood

Suspension

Elastic Webbing

Seat & Backrest

Multilayer HR Foam,
Polyester Wadding

Legs H 19cm

Solid Wood, included Silicone Pads
Oak - Natural / White Oil **(O/N)**
Oak - Black RAL 9005 **(O/B)**
American Walnut - Natural **(W/N)**

Upholstery

Fabric

Combinations

Proposal 01L
MA44

Proposal 01R
MA45

168×88cm



Proposal 02
MA25

216×88cm

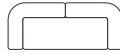

Proposal 03
MA30

256×88cm

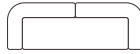

Proposal 04
MA26, MA27

376×88cm



Proposal 05L
MA26, MA43

Proposal 05R
MA42, MA27

296×168cm



Proposal 06L
MA25, MA27

Proposal 06R
MA26, MA25

216×276cm

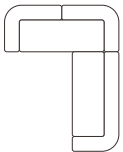

Proposal 07L
MA30, MA27

Proposal 07R
MA26, MA30

256×276cm

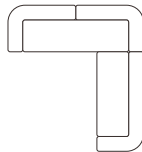

Proposal 08L
MA26, MA27, MA27

Proposal 08R
MA26, MA26, MA27

376×276cm

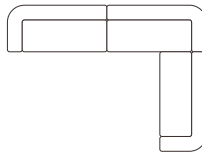

Proposal 09L
MA26, MA26, MA43

Proposal 09R
MA42, MA27, MA27

296×276cm

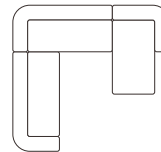

Proposal 10
MA26, MA26, MA27, MA27

376×276cm

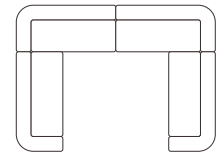

05 Tribeca

Elements

End Unit TR11
126×102×79cm

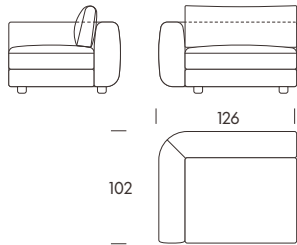

End Unit TR12
126×102×79cm

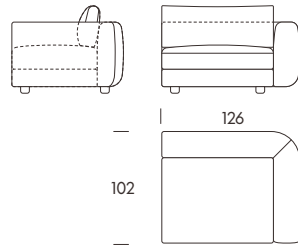

Armchair TR13
102×102×79cm

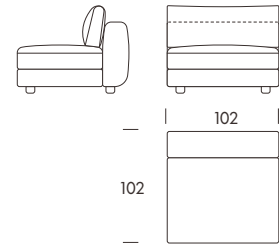

Three Seater Sofa TR30
252×102×79cm

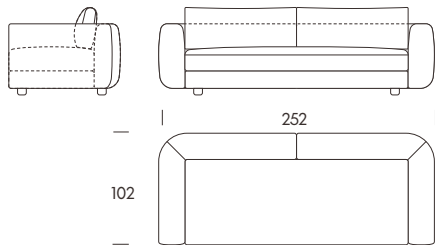

End Unit TR31
228×102×79cm

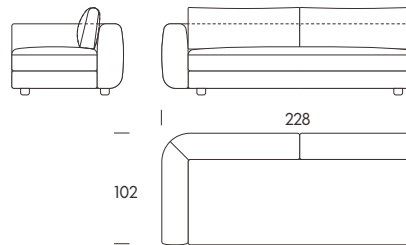

End Unit TR32
228×102×79cm

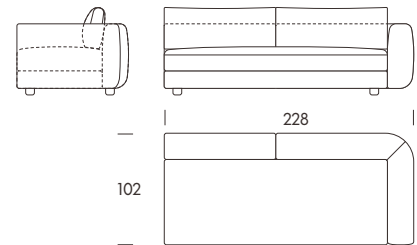

Extension TR33
204×102×79cm

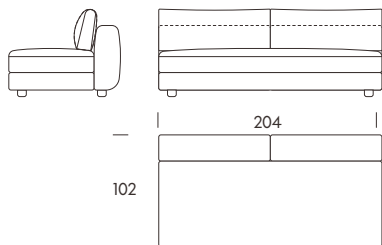

One Seater Extension TR40
160×102×79cm

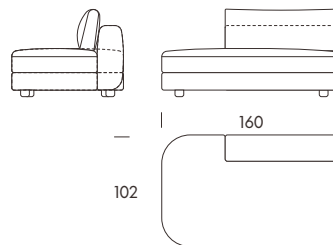

One Seater Extension TR41
160×102×79cm

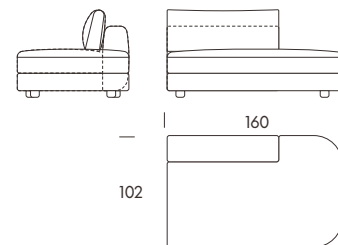

Height	79cm
Seat Height	44cm
Seat Depth	78cm
Seat Depth with cushion	60cm

Structure Solid Wood, Multilayer Plywood

Suspension Elastic Webbing

Seat & Backrest Multilayer HR Foam, Polyester Wadding

Cushions Feathering

Legs H 6cm Solid Wood, included Silicone Pads
Black RAL 9005

Upholstery Fabric

Chaise Longue TR42
126×184×79cm

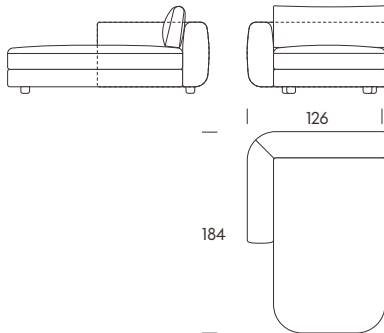

Chaise Longue TR43
126×184×79cm

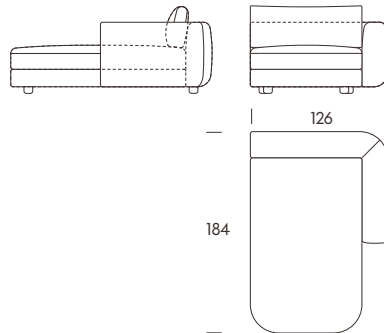

One Seater TR44
184×102×79cm

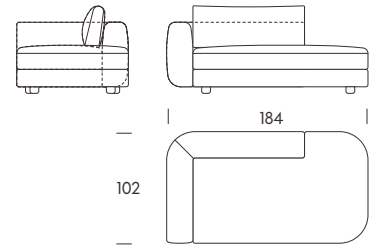

One Seater TR45
184×102×79cm

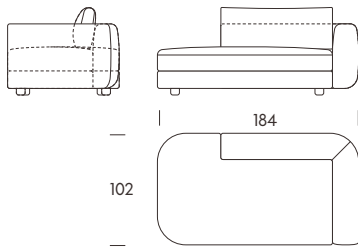

Coffee Table Extension TR60 Table
60×102×22cm

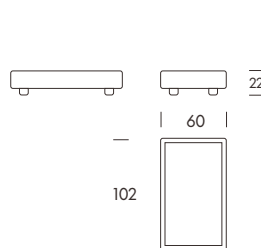

Pouf TR102
102×102×44cm

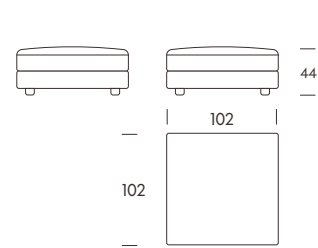

Pouf TR60
60×102×44cm

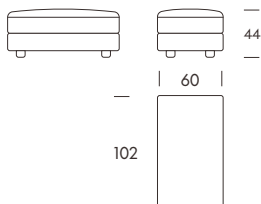

Pet Bed Extension TR60 Pet
60×102×32cm

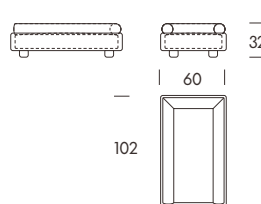

Combinations

Proposal 01
TR13

102×102cm



Proposal 02
TR30

252×102cm



Proposal 03L
TR44

Proposal 03R
TR45

184×102cm



Proposal 04L
TR31, TR60 Table

Proposal 04R
TR60 Table, TR32

288×102cm

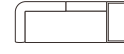

Proposal 05L
TR31, TR102

Proposal 05R
TR102, TR32

330×102cm

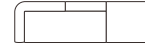

Proposal 06L
TR31, TR41

Proposal 06R
TR40, TR32

388×102cm



Proposal 07
TR31, TR32

456×102cm



Proposal 08L
TR31, TR43

Proposal 08R
TR42, TR32

354×184cm

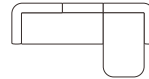

Proposal 09L
TR31, TR60 Table, TR43

Proposal 09R
TR42, TR60 Table, TR32

414×184cm

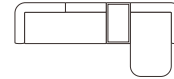

Proposal 10L
TR31, TR102, TR43

Proposal 10R
TR42, TR102, TR32

456×184cm

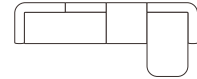

Proposal 11L
TR31, TR13, TR43

Proposal 11R
TR42, TR13, TR32

456×184cm



Proposal 12L
TR40, TR43

Proposal 12R
TR42, TR41

286×184cm

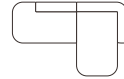

Proposal 13L
TR102, TR13, TR43

Proposal 13R
TR42, TR13, TR102

330×184cm

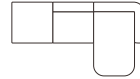

Proposal 14L
TR40, TR13, TR43

Proposal 14R
TR42, TR13, TR41

388×184cm



Proposal 15L
TR60 Table, TR33, TR43

Proposal 15R
TR42, TR33, TR60 Table

390×184cm

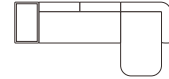

Proposal 16L
TR102, TR33, TR43

Proposal 16R
TR42, TR33, TR102

432×184cm

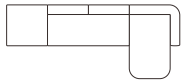

Proposal 17L
TR40, TR33, TR43

Proposal 17R
TR42, TR33, TR41

490×184cm

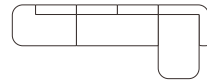

Proposal 18
TR40, TR41

320×102cm



Proposal 19
TR40, TR13, TR41

422×102cm



Proposal 20L
TR31, TR30

Proposal 20R
TR30, TR32

330×252cm

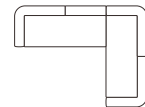

Proposal 21L
TR31, TR60 Table, TR30

Proposal 21R
TR30, TR60 Table, TR32

390×252cm

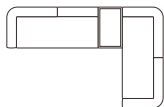

Proposal 22L
TR31, TR102, TR30

Proposal 22R
TR30, TR102, TR32

432×252cm

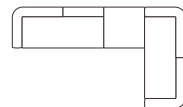

Proposal 23L
TR31, TR13, TR30

Proposal 23R
TR30, TR13, TR32

432×252cm

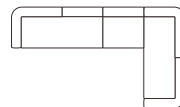

Proposal 24L
TR60 Table, TR33, TR30

Proposal 24R
TR30, TR33, TR60 Table

366×252cm

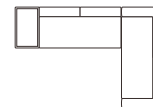

Proposal 25L
TR102, TR33, TR30

Proposal 25R
TR30, TR33, TR102

408×252cm

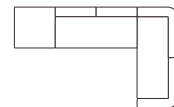

Proposal 26L
TR40, TR33, TR30

Proposal 26R
TR30, TR33, TR41

466×252cm

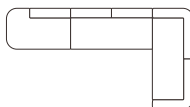

Proposal 27L
TR31, TR31, TR60 Table

Proposal 27R
TR60 Table, TR32, TR32

330×288cm

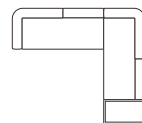

Proposal 28L
TR31, TR31, TR102

Proposal 28R
TR102, TR32, TR32

330×330cm

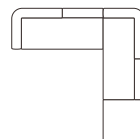

Proposal 29L
TR31, TR31, TR12

Proposal 29R
TR11, TR32, TR32

330×354cm

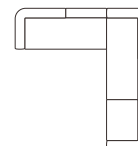

Proposal 30L
TR31, TR31, TR43

Proposal 30R
TR42, TR32, TR32

330×354cm

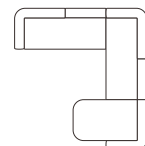

Proposal 31L
TR31, TR31, TR41

Proposal 31R
TR40, TR32, TR32

330×388cm

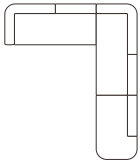

Proposal 32L
TR31, TR31, TR32

Proposal 32R
TR31, TR32, TR32

330×456cm

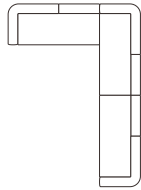

Proposal 33L
TR31, TR33, TR31, TR32

Proposal 33R
TR31, TR32, TR33, TR32

534×456cm

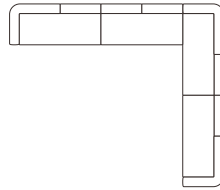

Proposal 34L
TR31, TR60 Table, TR31, TR41

Proposal 34R
TR40, TR32, TR60 Table, TR32

390×388cm

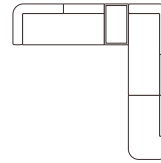

Proposal 35L
TR31, TR102, TR31, TR41

Proposal 35R
TR40, TR32, TR102, TR32

432×388cm

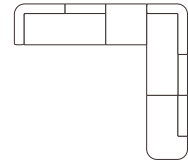

Proposal 36L
TR31, TR13, TR31, TR41

Proposal 36R
TR40, TR32, TR13, TR32

432×388cm

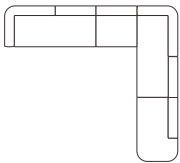

Proposal 37L
TR31, TR33, TR31, TR41

Proposal 37R
TR40, TR32, TR33, TR32

534×388cm

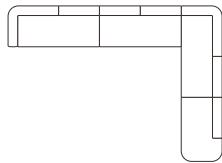

Proposal 38L
TR40, TR33, TR31, TR13, TR43

Proposal 38R
TR42, TR13, TR32, TR33, TR41

466×456cm

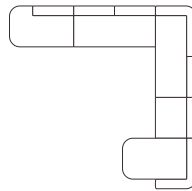

Proposal 39L
TR40, TR33, TR31, TR41

Proposal 39R
TR40, TR32, TR33, TR41

466×388cm

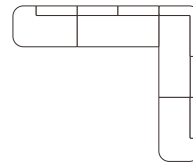

Proposal 40L
TR40, TR33, TR31, TR32

Proposal 40R
TR31, TR32, TR33, TR41

466×456cm

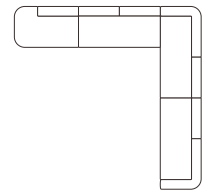

Proposal 41
TR31, TR102, TR32

330×330cm

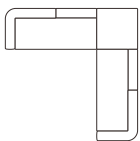

Proposal 42L
TR31, TR102, TR33, TR43

Proposal 42R
TR42, TR33, TR102, TR32

330×432cm

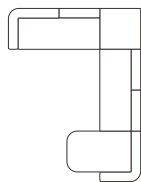

Proposal 43
TR11, TR33, TR102, TR33, TR12

432×432cm

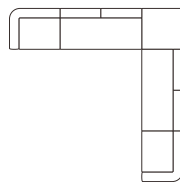

Proposal 44
TR40, TR33, TR102, TR33, TR41

466×466cm

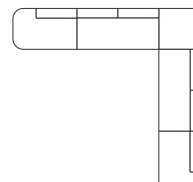

Proposal 45L
TR40, TR33, TR102, TR33, TR43

Proposal 45R
TR42, TR33, TR102, TR33, TR41

466×432cm

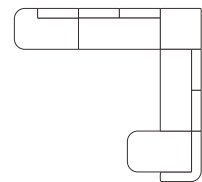

Proposal 46
TR31, TR33, TR102, TR33, TR32

534×534cm

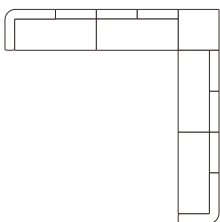

Proposal 47
TR11, TR12

252×102cm



Proposal 48
TR11, TR13, TR12

354×102cm



Proposal 49
TR11, TR13, TR13, TR12

456×102cm

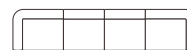

Proposal 50L
TR11, TR13, TR13, TR41

Proposal 50R
TR40, TR13, TR13, TR12

490×102cm



Proposal 51L
TR11, TR13, TR13, TR43

Proposal 51R
TR42, TR13, TR13, TR12

456×184cm

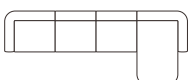

Proposal 52L
TR40, TR13, TR13, TR43

Proposal 52R
TR42, TR13, TR13, TR41

490×184cm

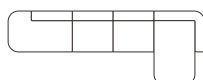

Proposal 53
TR11, TR13, TR13, TR102, TR13, TR12

432×432cm

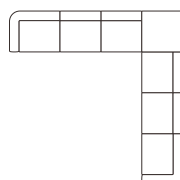

Proposal 54L
TR11, TR13, TR13, TR102, TR13, TR13, TR43

Proposal 54R
TR42, TR13, TR13, TR102, TR13, TR13, TR12

432×432cm

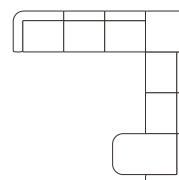

06 Kubik

Elements

Two Seater Sofa KU25
200×101×79cm

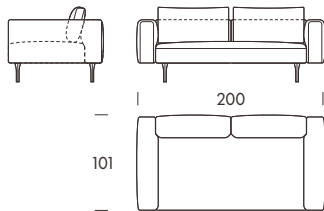

Three Seater Sofa KU30
240×101×79cm

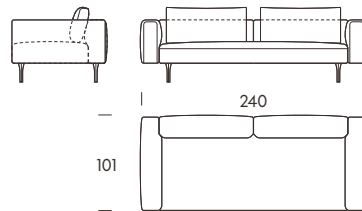

End Unit KU31
220×101×79cm

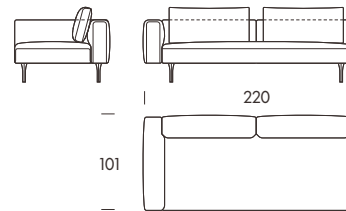

End Unit KU32
220×101×79cm

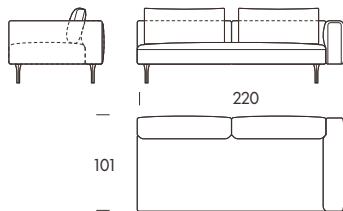

One Seater Extension KU40
160×101×79cm

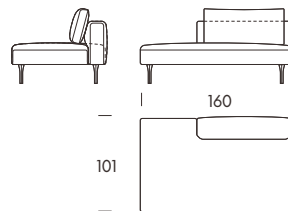

One Seater Extension KU41
160×101×79cm

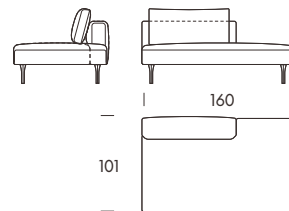

Chaise Longue KU42
120×180×79cm

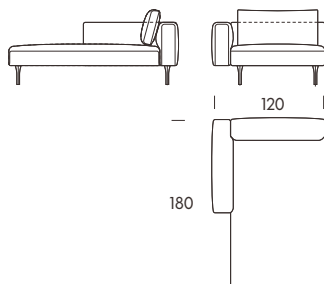

Chaise Longue KU43
120×180×79cm

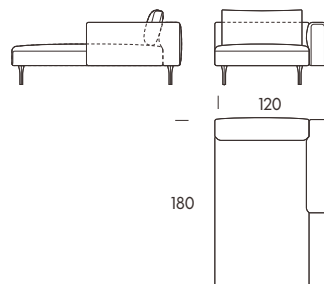

Pouf KU80
80×80×43cm

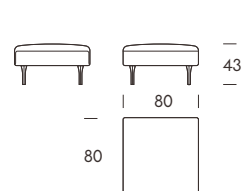

Height 79cm
 Seat Height 43cm
 Seat Depth 79cm
 Seat Depth with cushion 61cm

Structure Solid Wood, Multilayer Plywood

Suspension Elastic Webbing

Cushions Feathering

Seat & Backrest Multilayer HR Foam, Polyester Wadding

Legs H 20cm

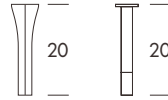

Solid Wood, included Silicone Pads
 Oak - Natural / White Oil (**O/N**)
 Oak - Black RAL 9005 (**O/B**)
 American Walnut - Natural / Oil (**W/N**)

Metal, included Silicone Pads
 Metal - Black RAL 9005 - ø25mm
 + Wooden Tap ø25mm, (**M/B**)

Upholstery Fabric

Combinations

Proposal 01
 KU25

200×101cm



Proposal 02
 KU30

240×101cm



Proposal 03L
 KU31, KU41

Proposal 03R
 KU40, KU32
 380×101cm

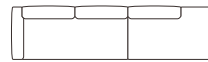

Proposal 04L
 KU31, KU43

Proposal 04R
 KU42, KU32
 340×180cm

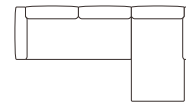

Proposal 05
 KU31, KU32

440×101cm

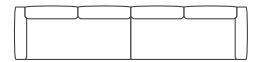

Proposal 06L
 KU31, KU30

Proposal 06R
 KU30, KU32

321×240cm

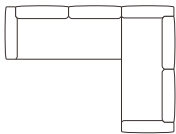

Proposal 07L
 KU40, KU43

Proposal 07R
 KU42, KU41

280×180cm

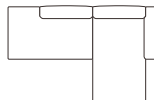

Proposal 08
 KU40, KU41

320×101cm



Proposal 09L
 KU31, KU31, KU43

Proposal 09R
 KU42, KU32, KU32

321×340cm

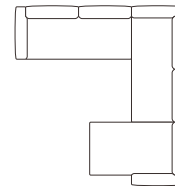

Proposal 10L
 KU31, KU32, KU32

Proposal 10R
 KU31, KU31, KU32

440×321cm

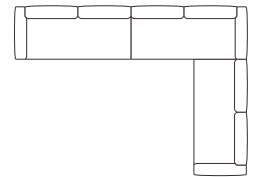

Proposal 11
 KU31, KU 31, KU32, KU32

440×321cm

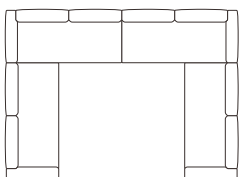

07 Panama

Elements

Two Seater Sofa PA25
192×95×80cm

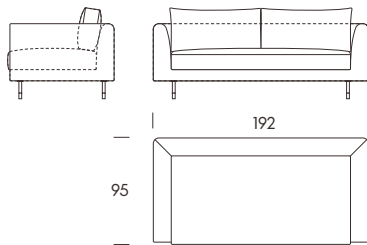

End Unit PA26
176×95×80cm

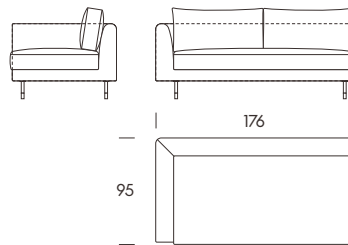

End Unit PA27
176×95×80cm

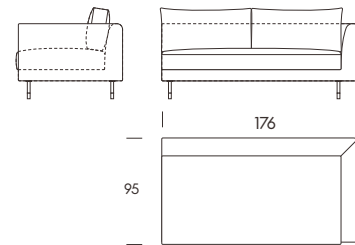

Three Seater Sofa PA30
232×95×80cm

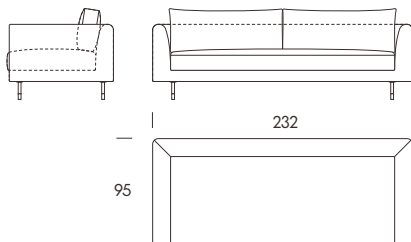

Chaise Longue PA42
96×172×80cm

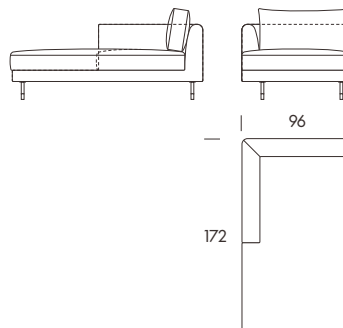

Chaise Longue PA43
96×172×80cm

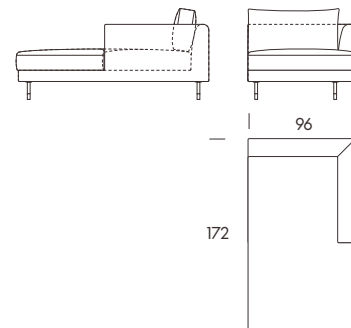

Pouf PA80
80×80×45cm

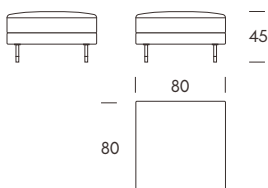

Height	80cm
Seat Height	45cm
Seat Depth	79cm
Seat Depth with cushion	62cm

Structure Solid Wood, Multilayer Plywood

Suspension Elastic Webbing

Seat & Backrest Multilayer HR Foam, Polyester Wadding

Cushions Feathering

Legs H 16cm Metal, included Silicone Pads
Metal - Black RAL 9005 - ø25mm
+ Wooden Tap ø25mm, (M/B)

Upholstery Fabric

Combinations

Proposal 01
PA25

192×95cm



Proposal 02
PA30

232×95cm



Proposal 03
PA26, PA27

352×95cm



Proposal 04L
PA26, PA43

Proposal 04R
PA42, PA27

272×172cm

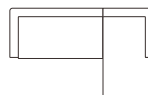

08 Cabrio

Height 71.5cm
 Seat Height 40cm
 Seat Depth 56cm

Structure	Solid Wood, Multilayer Plywood
Suspension	Elastic Webbing
Seat & Backrest	Multilayer HR Foam, Polyester Wadding
Legs H 24cm	Solid Wood, included Silicone Pads Oak - Natural / White Oil (O/N) Oak - Black RAL 9005 (O/B) American Walnut - Natural / Oil (W/N)
Upholstery	Fabric

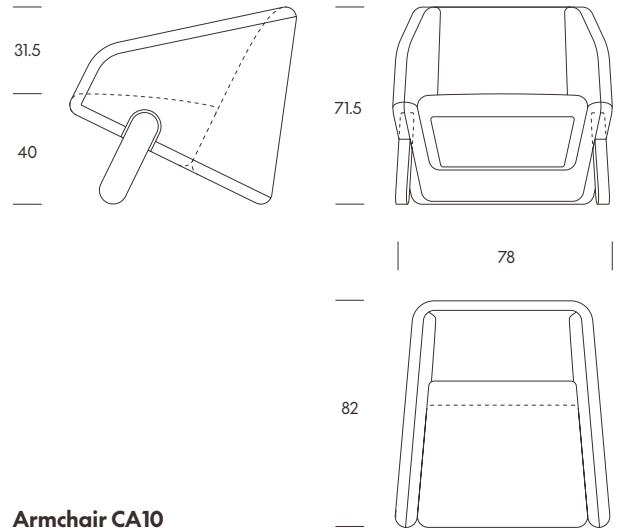

Armchair CA10

09 Mono

Height 69cm
 Seat Height 40cm
 Seat Depth 54cm

Structure	Solid Wood, Multilayer Plywood
Suspension	Elastic Webbing
Seat & Backrest	Multilayer HR Foam, Polyester Wadding
Legs H 24cm	Solid Wood, included Silicone Pads Oak - Natural / White Oil (O/N) Oak - Black RAL 9005 (O/B) American Walnut - Natural / Oil (W/N)
Upholstery	Fabric

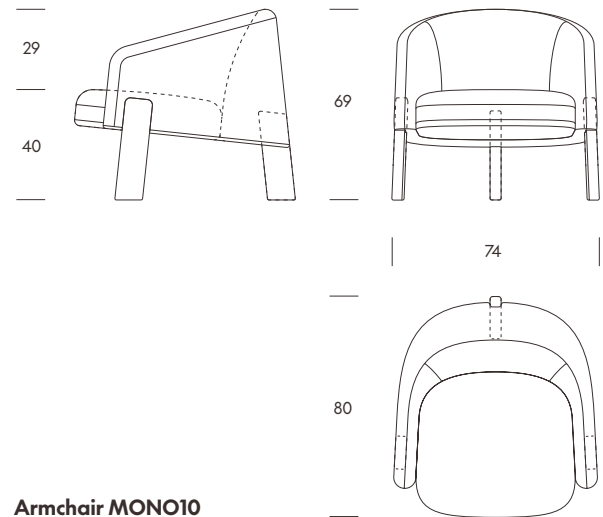

Armchair MONO10

10 Hippo

Height 69cm
 Seat Height 40cm
 Seat Depth 56cm

Structure	Solid Wood, Multilayer Plywood
Suspension	Elastic Webbing
Seat & Backrest	Multilayer HR Foam, Polyester Wadding
Rotating Base H 5 cm	Solid Wood / Black RAL 9005 included Silicone Pads
Upholstery	Fabric

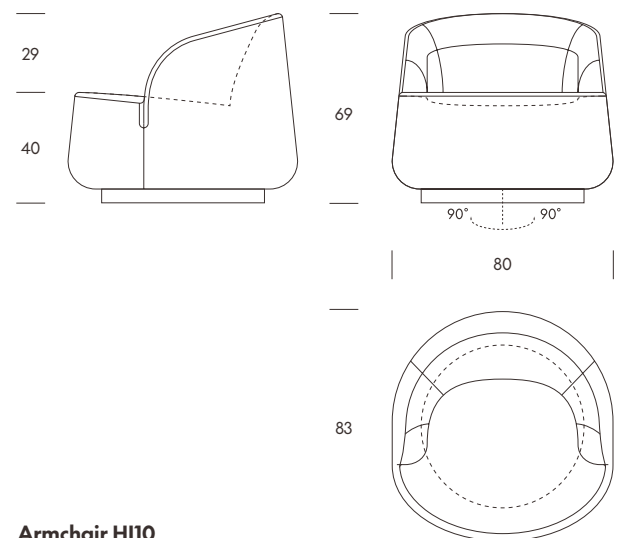

Armchair HI10

11 Aspen

Height 68cm
 Seat Height 40cm
 Seat Depth 57cm

Structure Solid Wood, Multilayer Plywood

Suspension Elastic Webbing

Seat & Backrest Multilayer HR Foam, Polyester Wadding

Rotating Base H 5cm Solid Wood / Black RAL 9005
 included Silicone Pads

Upholstery Fabric

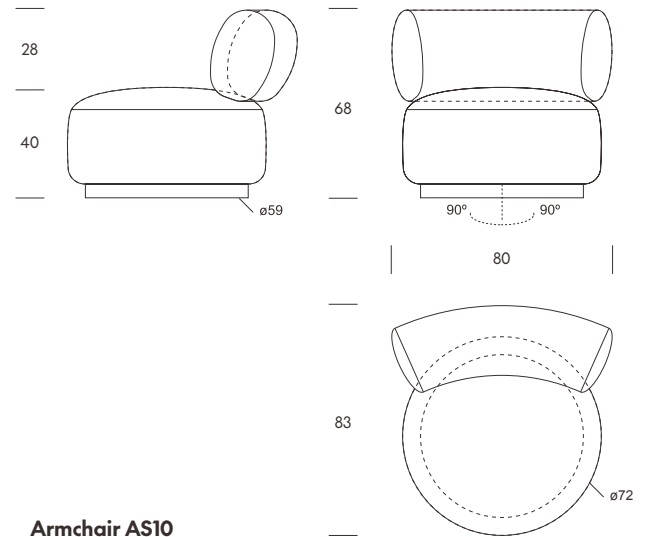

Armchair AS10

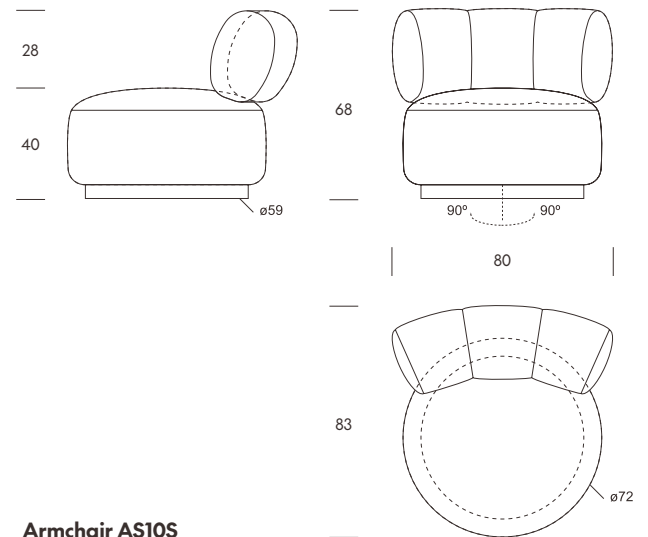



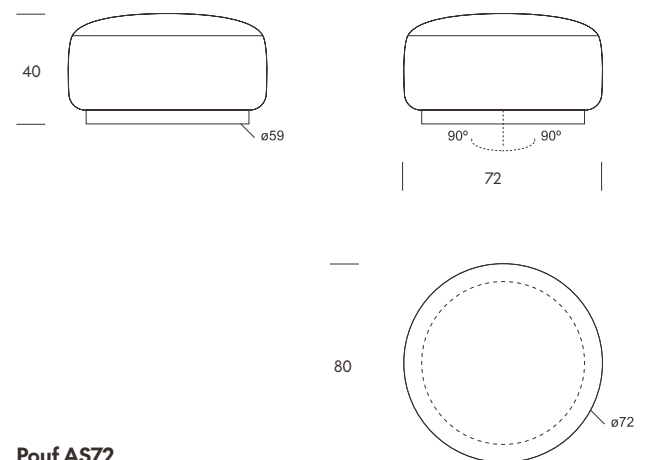





































































































Armchair AS10S















Pouf AS72



Fabric Specification

Cat.	Fabric	Producer	Specification	Pilling	Martindale cycles	Light fastness	Maintenance
100	Game	Mercis	100% PES	4-5	≥60.000	7	       
100	Azalea	Textum	100% PES	4-5	≥100.000	5	       
200	Azura	Textum	75% PES 12% A 8% CO 5% WO	4	≥50.000	4	       
200	Nomi	Textum	95% PES 5% A	4	≥50.000	4	       
300	Pepe Plus	Limonta	75% Recycled CO 25% PL	4	≥40.000	5-6	       
400	Lario	Limonta	42% Recycled CO 26% PL 32% PC	4	≥45.000	5-6	       
500	Blackwood	Limonta	32% VI 31% CO 15% PL 14% LI 8% PC	3-4	≥30.000	5-6	       
500	Main Line Flax	Camira	75% Virgin Wool 25% Flax	3-4	≥50.000	4-5	       
700	Yoredale	Camira	95% WO 3% PES 2% PA	4	≥50.000	5	       
700	Boemian	Torri Lana	5% CO 25% VI 13% LI 15% WO 25% PL 15% PC 2% PA	4	≥45.000	4-5	       
700	Rico	Torri Lana	56% CO 30% VI 14% LI	3-4	≥36.000	4-5	       
700	Mazurka	Mario Sirtori	88% CO 12% PL	4-5	≥30.000	4-5	       
900	Orsetto	Mario Sirtori	34% VI 33% PC 17% WO 8% PL 4% LI 4% CO	5	≥80.000	4-5	       

											
Do not bleach	Wash at or below 30°C	Wash at or below 40°C	Do not wash	Do not iron	Iron at low temperature	Dry clean with PCE	Gentle dry clean with PCE	Very gentle dry clean with PCE	Do not dry clean	Tumble dry, low heat	Do not tumble dry

Availability

● Recommended ○ Available

	Game	Azalea	Azura	Nomi	Pepe Plus	Lario	Blackwood	Main Line Flax	Yoredale	Boemian	Rico	Mazurka	Orsetto
	100	100	200	200	300	400	500	500	700	700	700	700	900
Dolmen	●	●	●	●	○	●	○	●	○	○	●	●	●
Monolite	●	●	●	●	●	●	○	●	○	○	●	●	●
Le Mans		●	●	●		●	●	●	●	●	●	●	●
Mandarin			●	●		●	●	●	●	●	●	●	●
Tribeca		●	●	●		●	●	●	○	●	●		●
Kubik		●	●	●	●	●	●	●	●	●	●	○	●
Panama		●	●	●	●	●	●	●	●	●	●		●
Cabrio	●		●	●	●	●	●	●	●	●	●	●	●
Mono	●		●	●		●	●	●	●	●	●	●	●
Hippo	●								●	●	●		●
Aspen	●					●	●	●	●	●	●	●	●

Game - Cat. 100

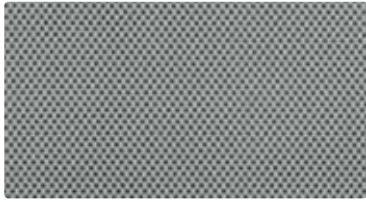

Game 16



Game 17



Game 27



Game 33

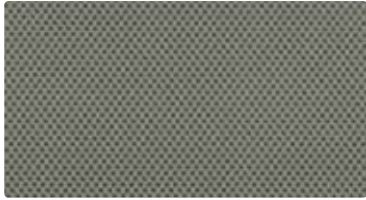

Game 34



Game 35



Game 36



Game 38

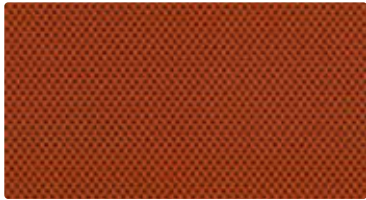

Game 39



Game 44



Game 47



Game 53



Game 58



Game 63



Game 66



Game 68

Name of the Fabric	Game
Producer	Mercis
Category	100
Composition	100% PES
Weight	500 g/m ² ±5%
Abrasion Resistance	≥60.000 Martindale
Flammability	DIN EN 1021-1(without soaking), BS 5852 Source 0(without soaking)
Light Fastness	7 (DIN EN ISO 105-B02)
Fastness to Rubbing	Wet: 4 to 5 Dry: 4 to 5 (DIN EN ISO 105-X12)

Azalea - Cat. 100



Azalea 9107



Azalea 9206

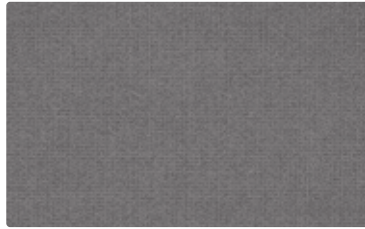

Azalea 9502



Azalea 9516



Azalea 9534



Azalea 9852



Azalea 9884

Name of the Fabric	Azalea
Producer	Textum
Category	100
Composition	100% PES
Weight	569 g/m2 ±5%
Abrasion Resistance	≥100.000 Martindale
Flammability	BS 5852 - Cigarette
Light Fastness	5 (EN ISO 105-X1)
Fastness to Rubbing	Wet: 4 to 5 Dry: 5 (EN ISO 105-X1)

Azura - Cat.200



Azura 9129



Azura 9133



Azura 9153

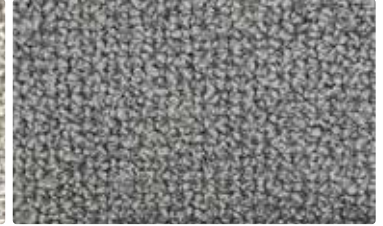

Azura 9247



Azura 9414



Azura 9562

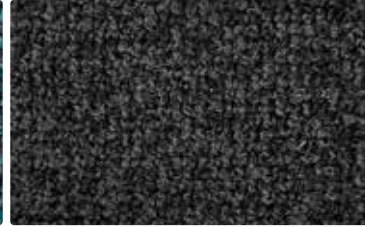

Azura 9937



Azura 9981

Name of the Fabric	Azura
Producer	Textum
Category	200
Composition	75% PES 12% A 8% CO 5% WO
Weight	585 g/m2 ±5%
Abrasion Resistance	≥50.000 Martindale
Flammability	EN ISO 1021-1 - Cigarette
Light Fastness	4 (EN ISO 105-X1)
Fastness to Rubbing	Wet: 4 to 5 Dry: 4 to 5 (EN ISO 105-X1)

Nomi - Cat. 200



Nomi 9048



Nomi 9163



Nomi 9206



Nomi 9247



Nomi 9960

Name of the Fabric	Nomi
Producer	Textum
Category	200
Composition	95% PES 5% A
Weight	880 g/m2 ±5%
Abrasion Resistance	≥50.000 Martindale
Flammability	EN ISO 1021-1 - Cigarette
Light Fastness	4 (EN ISO 105-X1)
Fastness to Rubbing	Wet: 4 to 5 Dry: 4 to 5 (EN ISO 105-X1)

Pepe Plus - Cat. 300



Pepe Plus 02



Pepe Plus 04



Pepe Plus 06



Pepe Plus 11



Pepe Plus 112



Pepe Plus 115



Pepe Plus 13



Pepe Plus 15

Name of the Fabric	Pepe Plus
Producer	Limonta
Category	300
Composition	75% Recycled CO 25% PL
Weight	510 g/m2 ±5%
Abrasion Resistance	≥40.000 Martindale (UNI EN ISO 12947-2)
Flammability	BS 5852 -sez.4 part.1 Cigarette
Light Fastness	5/6 (UNI EN ISO 105-B02)
Fastness to Rubbing	Wet: 3 Dry: 4 (EN ISO 105-X12)

Lario - Cat. 400



Lario 09



Lario 12

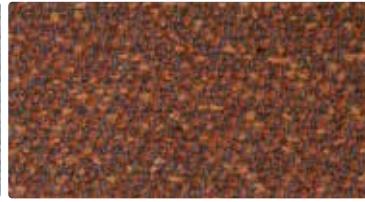

Lario 15



Lario 17



Lario 65



Lario 97



Lario 100



Lario 111



Lario 118



Lario 119

Name of the Fabric	Lario
Producer	Limonta
Category	400
Composition	42% Recycled CO 26% PL 32% PC
Weight	980 g/m2 ±5%
Abrasion Resistance	≥45.000 Martindale (UNI EN ISO 12947-2)
Flammability	BS 5852 - 1 Cigarette BS 5852 - 2 Match CAL TB 117 BS 5852 Crib5 with Treatment
Light Fastness	5/6 (UNI EN ISO 105-B02)
Fastness to Rubbing	Wet: 3 Dry: 4 to 5 (EN ISO 105-X12)

Main Line Flax - Cat. 500



Main Line Flax 02



Main Line Flax 05

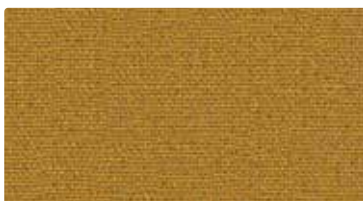

Main Line Flax 17



Main Line Flax 19



Main Line Flax 45



Main Line Flax 46



Main Line Flax 48



Main Line Flax 50



Main Line Flax 55



Main Line Flax 57



Main Line Flax 63

Name of the Fabric	Main Line Flax
Producer	Camira
Category	500
Composition	75% Virgin Wool 25% Flax
Weight	437 g/m ² ±5%
Abrasion Resistance	≥50.000 Martindale
Flammability	EN 1021 - 1 Cigarette EN 1021 - 2 Match BS 7176 Low Hazard BS 5852 Ignition Source 5 BS 7176 Medium Hazard NF D 60-013 ÖNORM B 3825 & A 3800-1 (58 kg/m ³ CMHR Foam) UNI 9175 Classe 1 IM BS 476 Part 7 Class 1 (Adhered) EN 13501-1 Adhered Class B, s1, d0 BS 5867-2: Type B Curtains & Drapes IMO FTP Code (Part 8) The Furniture and Furnishing (Fire Safety) Regulations 1988 (UK domestic cigarette and match)
Light Fastness	4 (EN ISO 105-X1)
Fastness to Rubbing	Wet: 4 to 5 Dry: 4 to 5 (EN ISO 105-X1)

Blackwood - Cat. 500



Blackwood 02



Blackwood 04



Blackwood 05



Blackwood 06



Blackwood 07



Blackwood 08

Name of the Fabric	Blackwood
Producer	Limonta
Category	500
Composition	32% VI 31% CO 15% PL 14% LI 8% PC
Weight	775 g/m2 ±5%
Abrasion Resistance	≥30.000 Martindale (UNI EN ISO 12947-2)
Flammability	BS 5852 - 1 Cigarette BS 5852 - 2 Match CAL TB 117 BS 5852 Crib5 with Treatment
Light Fastness	5/6 (UNI EN ISO 105-B02)
Fastness to Rubbing	Wet: 3 Dry: 4 (UNI EN ISO 105-X12)

Yoredale - Cat. 700

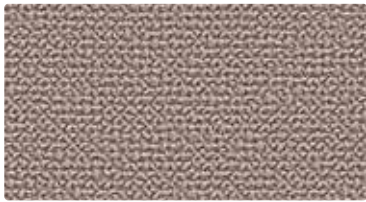

Yoredale 02

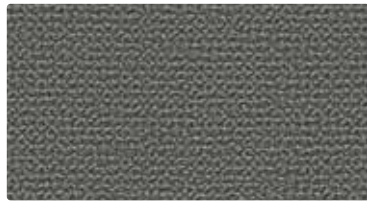

Yoredale 04



Yoredale 05



Yoredale 08

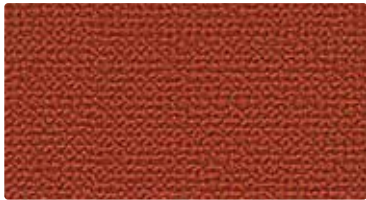

Yoredale 13



Yoredale 17

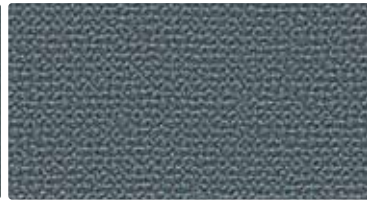

Yoredale 22



Yoredale 25



Yoredale 28



Yoredale 29



Yoredale 31



Yoredale 35



Yoredale 36



Yoredale 38

Name of the Fabric	Yoredale
Producer	Camira
Category	700
Composition	95% WO 3% PES 2% PA
Weight	750 g/m ² ±5%
Abrasion Resistance	≥50.000 Martindale
Flammability	EN 1021 - 1 Cigarette EN 1021 - 2 Match BS 7176 Low Hazard ÖNORM B 3825 & A 3800-1 (58 kg/m ³ CMHR Foam) UNI 9175 Classe 1 IM IMO FTP Code (Part 8) The Furniture and Furnishing (Fire Safety) Regulations 1988 (UK domestic cigarette and match) Optional: Please specify when ordering BS 5852 Ignition Source 5 when FR treated BS 7176 Medium Hazard when FR treated
Light Fastness	5 (UNI EN ISO 105-B02)
Fastness to Rubbing	Wet: 4 Dry: 4 (UNI EN ISO 105-X12)

Mazurka - Cat.700



Mazurka 01

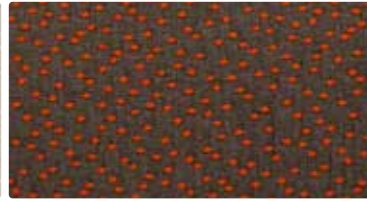

Mazurka 11

Name of the Fabric	Mazurka
Producer	Mario Sirtori
Category	700
Composition	88% CO 12% PL
Weight	767 g/m2 ±5%
Abrasion Resistance	≥30.000 Martindale (UNI EN ISO 12947-2)
Flammability	
Light Fastness	4/5 (UNI EN ISO 105-B02)
Fastness to Rubbing	Wet: 5 Dry: 5 (UNI EN ISO 105-X12)

Boemian - Cat. 700



Boemian 624.000



Boemian 624.010



Boemian 624.040

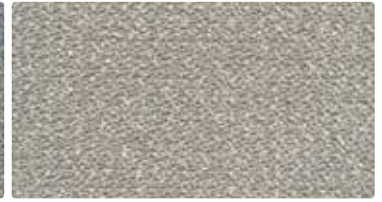

Boemian 624.050



Boemian 624.060

Name of the Fabric	Boemian
Producer	Torri Lana
Category	700
Composition	5% CO 25% VI 13% LI 15% WO 25% PL 15% PC 2% PA
Weight	620 g/m2 ±5%
Abrasion Resistance	≥45.000 Martindale ±5%
Flammability	BS 5852-1 (1979) - 1 Cigarette BS 5852 (2006) - 1 Cigarette BS 5852-1 (1979) - 2 Match BS 5852 (2006) - 2 Match CAL TB 117 (2013)
Light Fastness	Light colour 4/5 Medium / Dark colour 5 (UNI EN ISO 105-B02)
Fastness to Rubbing	Wet: 2 to 3 (Black Wet 2) Dry: 4 to 5 (UNI EN ISO 105-X12)

Rico - Cat. 700



Rico 989.000



Rico 989.080

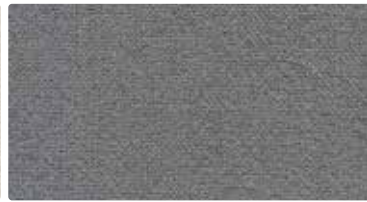

Rico 989.130



Rico 989.150



Rico 989.250



Rico 989.270



Rico 989.480



Rico 989.490



Rico 989.510

Name of the Fabric	Rico
Producer	Torri Lana
Category	700
Composition	56% CO 30% VI 14% LI
Weight	643 g/m2 ±5%
Abrasion Resistance	≥36.000 Martindale ±5% (UNI EN ISO 12947-2:2000)
Flammability	BS 5852 (2006) - 1 Cigarette Interliner BS 5852 (2006) - 2 Match Interliner CAL TB 117 (2013) - Fail BS 5852-1 (1979) - Match
Light Fastness	Light colour 4/5 Medium / Dark colour 5 (UNI EN ISO 105-B02)
Fastness to Rubbing	Wet: 2 to 3 (Black Wet 2) Dry: 4 to 5 (UNI EN ISO 105-X12)

Orsetto - Cat. 900



Orsetto 01/1



Orsetto 01/2



Orsetto 02/22



Orsetto 05/6



Orsetto 05/10



Orsetto 07/24



Orsetto 09/23



Orsetto 98/16



Orsetto 98/18

Name of the Fabric	Orsetto
Producer	Mario Sirtori
Category	900
Composition	34% VI 33% PC 17% WO 8% PL 4% LI 4% CO
Weight	940 g/m ² ±5%
Abrasion Resistance	≥80.000 Martindale (UNI EN ISO 12947-2)
Flammability	BS 5852-1 (1979) - 1 Cigarette BS 5852-1 (1979) - 2 Match TB117 (2013) EN1021-1-2 BS 5852 Crib5 with Treatment
Light Fastness	4/5 (UNI EN ISO 105-B02)
Fastness to Rubbing	Wet: 4 to 5 Dry: 5 (UNI EN ISO 105-X12)

Woods



Oak - Black



Oak - White Oil



Walnut - Natural Oil

Glass



Glass - Black

The purpose of this promotional material is to provide the necessary information. We kindly ask you to take into consideration that the printed or on-screen images may differ from the actual color varieties, textures and structures of the material.

We suggest you to contact our nearest authorized sales dealers for all queries regarding materials characteristics and appearance.

This Material Catalogue is valid from 01.06.2023, until new edition is published.



Made from FSC-certified wood and other controlled materials.



About the Designer

Zoran Jedrejic is a Designer and Art Director from Split, Croatia, with Italian background. After seven years of fruitful cooperation with Ettore Sottsass, he opened a design studio in Milan, and, recently, another one in Belgrade.

He has designed for many international brands, such as 3M, Artisan, Molteni&C, Dada Cucine, Fratelli Guzzini, Gir, Nambe', Segis, Superfos, Woak and Zavar, among others.

He has won many awards, including Red Dot - Best of the Best, IF Design Award, Design Plus, Compasso d'Oro, German Design Award, Dezeen Award and BIG SEE Award, and his works have been exhibited in prestigious museums such as MAK Wien, MART Rovereto, ICA Boston, MoMA NY and Ozone Centre Tokyo among others. Recently, he has been awarded as BIG SEE Visionary for the year 2021.

Simultaneously with his career in design, he has been engaged as a visiting professor at ISIA-Florence, NABA-Milano, IAAD-Torino and the Academy of Fine Arts-Belgrade.

Currently, his major goal is to develop and internationalize the regional design scene & industry, through his engagement as the Art Director of the Belgrade Furniture Fair, as well as of several regional design brands.

PUBLISHER

Volumen

HEAD OFFICEBilecka 2F,
78000 Banja Luka,
Bosnia and Herzegovina**ART DIRECTION**

Zoran Jedrejčić

PHONE

+387 66 237 855

MAIL

info@volumen.ba

WEBSITE

www.volumen.ba

Catalogue

CREATIVE DIRECTION

Metaklinika

GRAPHIC DESIGN

Metaklinika

PHOTOGRAPHY

Aleksej Vasić

TEXT

Jovana Buljugić – Trifunović

TRANSLATION

Milan Marković

SPECIAL THANKSTerra Panonica
Ksenija & Nick, Penn Hill**PRINTED BY**

Alta Nova, Belgrade

Printed in Belgrade 2023

Volumen reserves the right to change the technical specification of any product illustrated in this catalogue at any time and without prior warning. Deviations of +/- 3 cm in product dimensions are possible. We kindly invite you to contact us, or our authorized sales dealers in your country for any queries regarding product characteristics and appearance.

The purpose of this promotional material is to provide the necessary information. We kindly ask you to take into consideration that the printed or on-screen images may differ from the actual color varieties, textures and structures of the materials.

DOWNLOADS

Find more product information, product fact sheets, assembly instructions, lifestyle images, packshots and much more on our download site.

JOIN US

Follow us on social media to stay in the loop about new product releases, case stories and events.

[instagram.com/volumen.furniture](https://www.instagram.com/volumen.furniture)[pinterest.com/volumenfurniture](https://www.pinterest.com/volumenfurniture)[facebook.com/volumen.furniture](https://www.facebook.com/volumen.furniture)[linkedin.com/company/volumen-furniture](https://www.linkedin.com/company/volumen-furniture)

All rights reserved 2024 Volumen



Made from FSC-certified wood and other controlled materials.

Vol.

Vol.

01 Dolmen

02 Monolite

03 Le Mans

04 Mandarin

05 Tribeca

06 Kubik

Contact Bilecka 2F, 78000 Banja Luka,
Bosnia and Herzegovina

+387 66 237 855

info@volumen.ba
www.volumen.ba

Collection
23/24

Sofas
Armchairs
Poufs

07 Panama

08 Cabrio

09 Mono

10 Hippo

11 Aspen

All rights reserved 2024 Volumen