

# Dolmen System



Dolmen is a collection of modernist design in the best sense of the word, with contours that are sculptural and reduced to geometrical shapes. Its harmonious lines can easily fit each individual space, or taste. The elements of this system that are readily connectable in all directions, enable creation of an infinite number of spatial compositions, equally functional in either private, or public spaces. Rotation of the elements can also result in private zones that facilitate users' interaction. Modularity of the collection is perfectly combined with comfort, making Dolmen an epitome of highly functional furniture. The collection is designed as a harmonious and measured interplay of straight and rounded lines, where every piece brings comfort, even visually. With its

optional armrests made of solid oak or walnut, Dolmen introduces warmth into your home, but is also excellent in large offices, hotel lobbies, airport lounge areas, and other public spaces.

Designed by **Zoran Jedrejčić**

## Dolmen System



### General dimensions

Height	65cm
Seat Height	41cm
Seat Depth	64cm

**Structure** Solid Wood, Multilayer Plywood

**Suspension** Elastic Webbing

**Seat & Backrest** Multilayer HR Foam, Polyester Wadding

**Legs H 3cm** Solid Wood , included Silicone Pads Black RAL 9005

**Upholstery** Fabric

**Wooden Armrest** Oak - Natural / White Oil **(O/N)**  
Oak - Black RAL 9005 **(O/B)**  
American Walnut - Natural **(W/N)**

**Recommended fabrics** Orsetto, Mazurka, Rico, Main Line Flax, Lario, Nomi, Azura, Azalea

### Suggested Fabric Colours

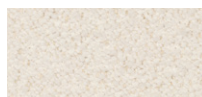

Volumen 900 – Orsetto 01/1

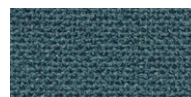

Volumen 700 – Rico 989.490



Volumen 100 – Game 27

### Wooden Armrest



Oak – Natural / White Oil



Oak – Black RAL 9005

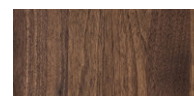

American Walnut – Natural Oil

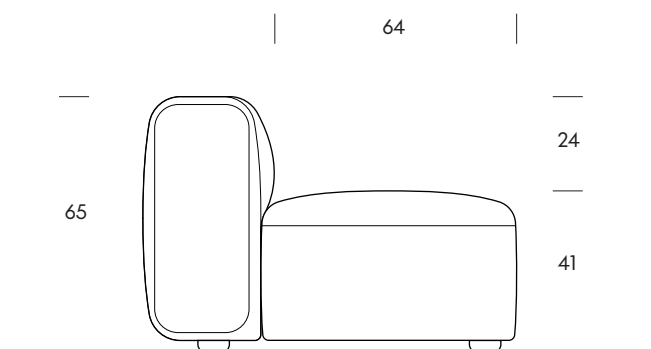

Product information website  
<http://volumen.ba/collection/dolmen/>



Made from FSC-certified wood and other controlled materials.

## Dolmen System

Seat Height  
Seat Depth  
Height

41cm  
64cm  
65cm

**Armchair DO10**  
73×97×65cm

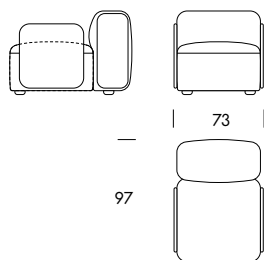

**End Unit DO11**  
70×97×65cm

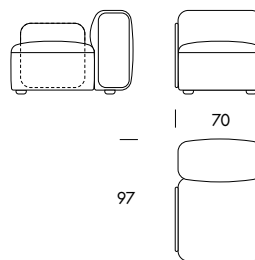

**End Unit DO12**  
70×97×65cm

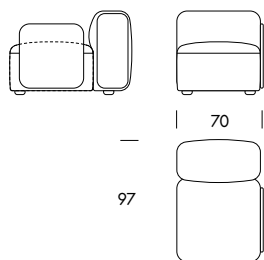

**Extension DO13**  
67×97×65cm

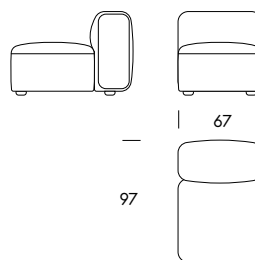

**Corner Unit DO50**  
97×97×65cm

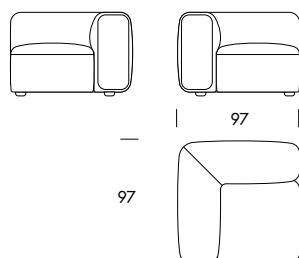

**Extension DO15**  
132×102×65cm

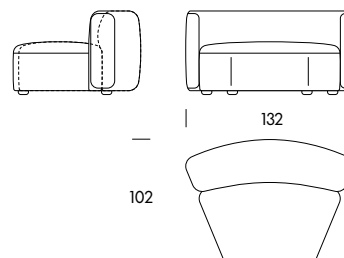

## Dolmen System

Seat Height  
Seat Depth  
Height

41cm  
64cm  
65cm

**Extension DO14**  
112×97×65cm

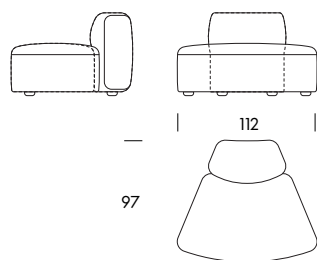

**Pouf DO67**  
67×67×41cm

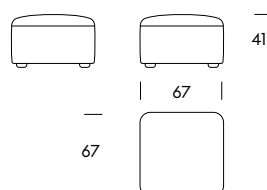

**Pouf DO97**  
97×67×41cm

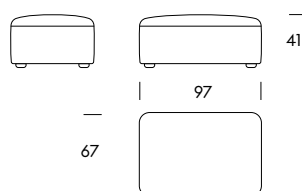

**Pouf DO112**  
112×71×41cm

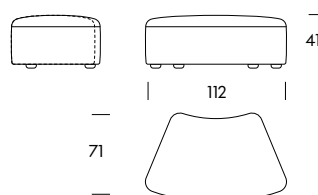

## Dolmen System

Seat Height  
Seat Depth  
Height

41cm  
64cm  
65cm

**Proposal 01**  
DO13

67×97cm



**Proposal 02**  
DO10

73×97cm



**Proposal 03**  
DO11, DO12

140×97cm



**Proposal 04**  
DO11, DO13, DO12

207×97cm



**Proposal 05**  
DO11, DO13, DO13,  
DO12

274×97cm



**Proposal 06L**  
DO97, DO13, DO13, DO12

271×97cm



**Proposal 06R**  
DO11, DO13, DO13, DO97

**Proposal 07L**  
DO11, DO97, DO13, DO12

274×97cm



**Proposal 07R**  
DO11, DO13, DO97, DO12

**Proposal 08L**  
DO11, DO13, DO13,  
DO12, DO67

274×164cm

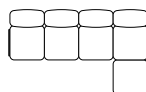

**Proposal 10L**  
DO11, DO13, DO13,  
DO15, DO97

374×164cm

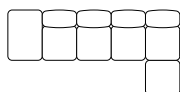

**Proposal 10L**  
DO11, DO13, DO13,  
DO15, DO97

374×164cm

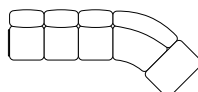

**Proposal 10R**  
DO97, DO15,  
DO13, DO13, DO12

**Proposal 11L**  
DO11, DO13, DO13,  
DO15, DO15, DO97

386×246cm

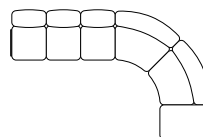

**Proposal 11R**  
DO97, DO15, DO15,  
DO13, DO13, DO12

**Proposal 12L**  
DO11, DO13, DO13, DO15, DO15,  
DO13, DO12

386×316cm

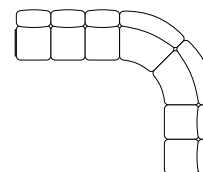

**Proposal 12R**  
DO11, DO13, DO15, DO15, DO13,  
DO13, DO12

**Proposal 13L**  
DO11, DO13, DO13, DO14,  
DO14, DO13, DO12

360×290cm

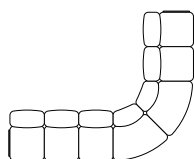

**Proposal 14L**  
DO11, DO13, DO13,  
DO14, DO97

350×155cm

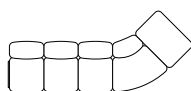

**Proposal 15L**  
DO11, DO13, DO13, DO14,  
DO14, DO97

360×220cm

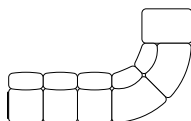

**Proposal 15R**  
DO97, DO14, DO14, DO13,  
DO13, DO12

**Proposal 16L**  
DO11, DO13, DO13,  
DO15, DO14, DO97

440×168cm

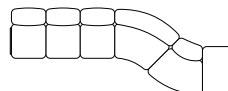

**Proposal 16R**  
DO97, DO14, DO15,  
DO13, DO13, DO12

**Proposal 17L**  
DO11, DO13, DO13, DO50,  
DO13, DO12

301×234cm

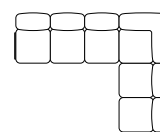

**Proposal 17R**  
DO11, DO13, DO50, DO13,  
DO13, DO12

**Proposal 18L**  
DO11, DO13, DO13, DO50,  
DO13, DO13, DO97

301×298cm

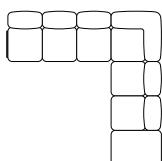

**Proposal 19L**  
DO11, DO13, DO13, DO50,  
DO13, DO13, DO12, DO67

301×301cm

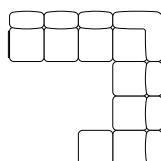

**Proposal 20**  
DO11, DO13, DO50, DO13, DO13,  
DO13, DO50, DO13, DO12

395×234cm

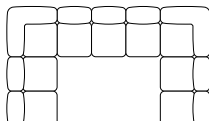

**Proposal 21L**  
DO11, DO13, DO13, DO13,  
DO97, DO13, DO13, DO12

338×301cm

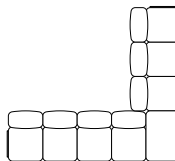

**Proposal 21R**  
DO11, DO13, DO13, DO97,  
DO13, DO13, DO13, DO12

## Dolmen System

**Seat Height**  
**Seat Depth**  
**Height**

41cm  
64cm  
65cm

**Proposal 22**  
DO50, DO50

194×97cm



**Proposal 23**  
DO50, DO13,  
DO50

261×97cm

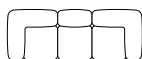

**Proposal 24**  
DO50, DO13,  
DO13, DO50

328×97cm



**Proposal 25L**  
DO97, DO13, DO13,  
DO50

**Proposal 25R**  
DO50, DO13, DO13,  
DO97

298×97cm



**Proposal 26L**  
DO50, DO97,  
DO13, DO50

**Proposal 26R**  
DO50, DO13,  
DO97, DO50

328×97cm



**Proposal 27L**  
DO50, DO13, DO13,  
DO50, DO97

**Proposal 27R**  
DO97, DO50, DO13,  
DO13, DO50

328×164cm

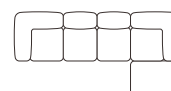

**Proposal 28L**  
DO97, DO13, DO13,  
DO13, DO50, DO97

**Proposal 28R**  
DO97, DO50, DO13,  
DO13, DO13, DO97

365×164cm

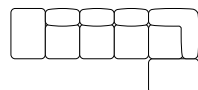

**Proposal 29L**  
DO50, DO13, DO13,  
DO15, DO97

**Proposal 29R**  
DO97, DO15, DO13,  
DO13, DO50

401×164cm

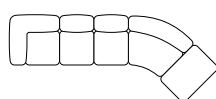

**Proposal 30L**  
DO50, DO13, DO13,  
DO15, DO15, DO97

**Proposal 30R**  
DO97, DO15, DO15,  
DO13, DO13, DO50

414×246cm

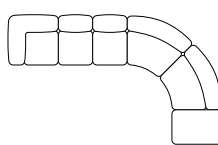

**Proposal 31L**  
DO50, DO13, DO13, DO15,  
DO15, DO13, DO50

**Proposal 31R**  
DO50, DO13, DO15, DO15,  
DO13, DO13, DO50

414×343cm

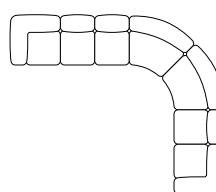

**Proposal 32L**  
DO50, DO13, DO13, DO14,  
DO14, DO13, DO50

**Proposal 32R**  
DO50, DO13, DO14, DO14,  
DO13, DO13, DO50

387×317cm

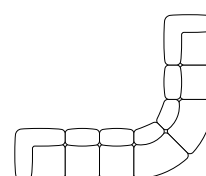

**Proposal 33L**  
DO50, DO13, DO13,  
DO14, DO97

**Proposal 33R**  
DO97, DO14, DO13,  
DO13, DO50

377×155cm

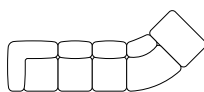

**Proposal 34L**  
DO50, DO13, DO13,  
DO14, DO14, DO97

**Proposal 34R**  
DO97, DO14, DO14,  
DO13, DO13, DO50

387×220cm

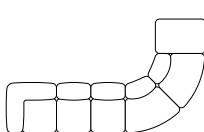

**Proposal 35L**  
DO50, DO13, DO13,  
DO15, DO14, DO97

**Proposal 35R**  
DO97, DO14, DO15,  
DO13, DO13, DO50

467×168cm

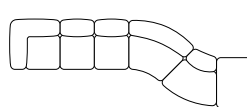

**Proposal 36L**  
DO50, DO13, DO13,  
DO50, DO13, DO50

**Proposal 36R**  
DO50, DO13, DO50,  
DO13, DO13, DO50

328×261cm

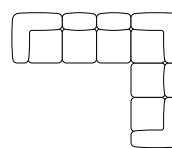

**Proposal 37L**  
DO50, DO13, DO13, DO50,  
DO13, DO13, DO97

**Proposal 37R**  
DO97, DO13, DO13, DO50,  
DO13, DO13, DO50

328×298cm

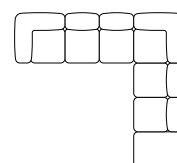

## Dolmen System

**Seat Height**  
**Seat Depth**  
**Height**

41cm  
64cm  
65cm

**Proposal 38L**

DO50, DO13, DO13, DO50,  
DO13, DO13, DO50, DO97

**Proposal 38R**

DO97, DO50, DO13, DO13,  
DO50, DO13, DO13, DO50

328×328cm

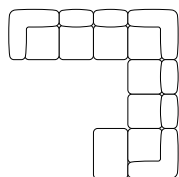

**Proposal 39**

DO50, DO13, DO50,  
DO13, DO13, DO13,  
DO50, DO13, DO50

395×261cm

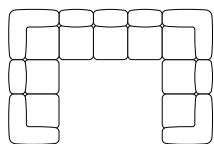

**Proposal 40L**

DO50, DO13, DO13, DO13,  
DO97, DO13, DO13, DO50

**Proposal 40R**

DO50, DO13, DO13, DO97,  
DO13, DO13, DO13, DO50

365×328cm

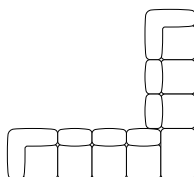

**Proposal 41**

DO15, DO15,  
DO15, DO15

360×180m

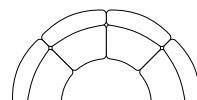

**Proposal 42**

DO15, DO15, DO13,  
DO13, DO15, DO15

494×180m

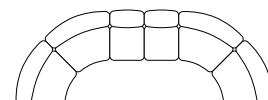

**Proposal 43**

DO13, DO14, DO15,  
DO15, DO14, DO13

474×164m

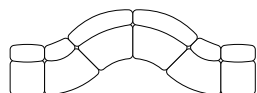

**Proposal 44**

DO14, DO14,  
DO14, DO14

308×154m

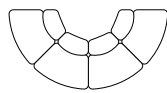

**Proposal 45**

DO14, DO14, DO13,  
DO13, DO14, DO14

442×154m

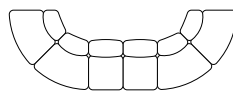

**Proposal 46**

DO14, DO14, DO15,  
DO15, DO14, DO14

548×164m

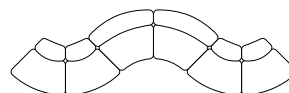

**Proposal 47**

DO112, DO112,  
DO112, DO112

308×154m

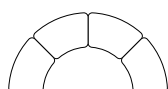

**Proposal 48**

DO112, DO112, DO67,  
DO67, DO112, DO112

434×154m

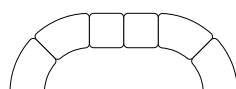

**Proposal 49**

DO67, DO112, DO112,  
DO112, DO112, DO67

474×136m

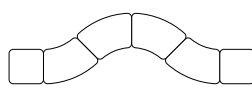

**Proposal 50**

DO112, DO112, DO112,  
DO112, DO112, DO112

548×136m

