

Dolmen System



Dolmen is a collection of modernist design in the best sense of the word, with contours that are sculptural and reduced to geometrical shapes. Its harmonious lines can easily fit each individual space, or taste. The elements of this system that are readily connectable in all directions, enable creation of an infinite number of spatial compositions, equally functional in either private, or public spaces. Rotation of the elements can also result in private zones that facilitate users' interaction. Modularity of the collection is perfectly combined with comfort, making Dolmen an epitome of highly functional furniture. The collection is designed as a harmonious and measured interplay of straight and rounded lines, where every piece brings comfort, even visually. With its

optional armrests made of solid oak or walnut, Dolmen introduces warmth into your home, but is also excellent in large offices, hotel lobbies, airport lounge areas, and other public spaces.

Designed by **Zoran Jedrejčić**

Dolmen System



General dimensions

Height	65cm
Seat Height	41cm
Seat Depth	64cm

Structure Solid Wood, Multilayer Plywood

Suspension Elastic Webbing

Seat & Backrest Multilayer HR Foam, Polyester Wadding

Legs H 3cm Solid Wood , included Silicone Pads Black RAL 9005

Upholstery Fabric

Wooden Armrest Oak - Natural / White Oil **(O/N)**
Oak - Black RAL 9005 **(O/B)**
American Walnut - Natural **(W/N)**

Recommended fabrics Orsetto, Mazurka, Rico, Main Line Flax, Lario, Nomi, Azura, Azalea

Suggested Fabric Colours:

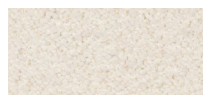

Volumen 900 – Orsetto 01/1



Volumen 700 – Rico 989.490

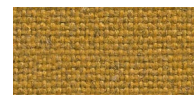

Volumen 500 – Main Line Flax 17

Wooden Armrest:



Oak – Natural / White Oil



Oak – Black RAL 9005

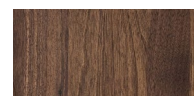

American Walnut – Natural Oil

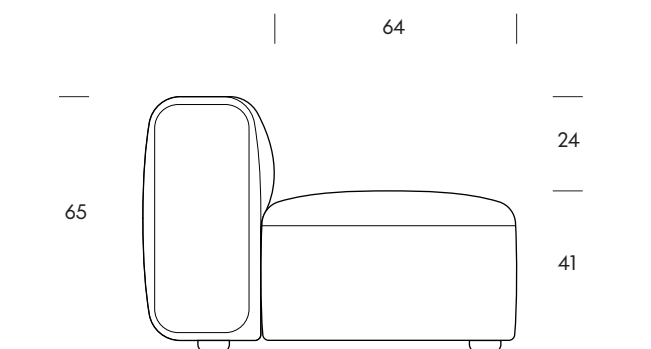

Product information website
<http://volumen.ba/collection/dolmen/>



Made from FSC-certified wood and other controlled materials.

Dolmen System

Seat Height
Seat Depth
Height

41cm
64cm
65cm

Armchair DO10
73×97×65cm

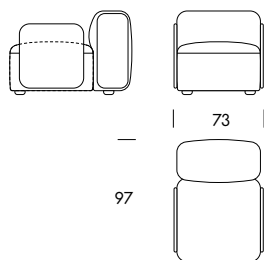

End Unit DO11
70×97×65cm

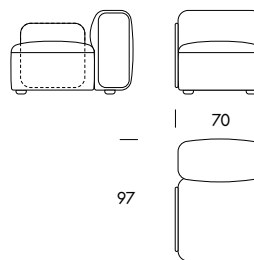

End Unit DO12
70×97×65cm

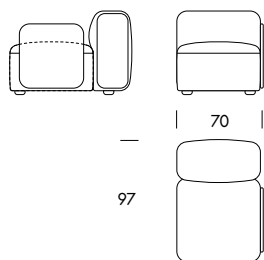

Extension DO13
67×97×65cm

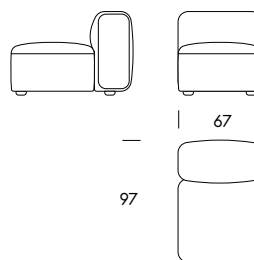

Corner Unit DO50
97×97×65cm

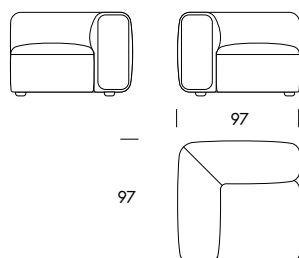

Extension DO15
132×102×65cm

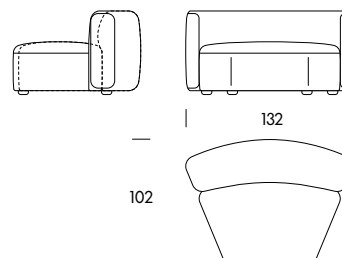

Dolmen System

Seat Height
Seat Depth
Height

41cm
64cm
65cm

Extension DO14
112×97×65cm

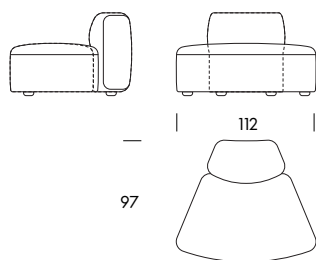

Pouf DO67
67×67×41cm

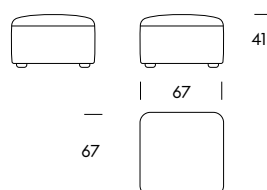

Pouf DO97
97×67×41cm

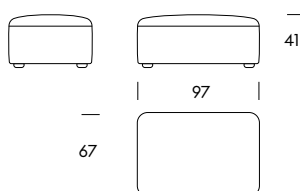

Pouf DO112
112×71×41cm

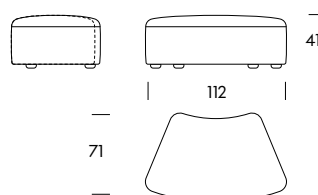

Dolmen System

Seat Height
Seat Depth
Height

41cm
64cm
65cm

Proposal 01
DO13

67×97cm



Proposal 02
DO10

73×97cm



Proposal 03
DO11, DO12

140×97cm



Proposal 04
DO11, DO13, DO12

207×97cm



Proposal 05
DO11, DO13, DO13,
DO12

274×97cm



Proposal 06L
DO97, DO13, DO13, DO12

271×97cm



Proposal 06R
DO11, DO13, DO13, DO97

Proposal 07L
DO11, DO97, DO13, DO12

274×97cm



Proposal 07R
DO11, DO13, DO97, DO12

Proposal 08L
DO11, DO13, DO13,
DO12, DO67

274×164cm

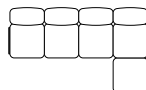

Proposal 10L
DO11, DO13, DO13,
DO15, DO97

374×164cm

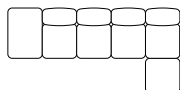

Proposal 10L
DO11, DO13, DO13,
DO15, DO97

374×164cm

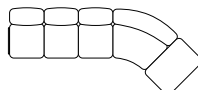

Proposal 10R
DO97, DO15,
DO13, DO13, DO12

Proposal 11L
DO11, DO13, DO13,
DO15, DO15, DO97

386×246cm

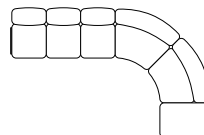

Proposal 11R
DO97, DO15, DO15,
DO13, DO13, DO12

Proposal 12L
DO11, DO13, DO13, DO15, DO15,
DO13, DO12

386×316cm

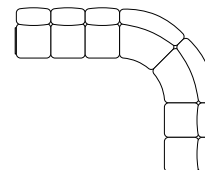

Proposal 12R
DO11, DO13, DO15, DO15, DO13,
DO13, DO12

Proposal 13L
DO11, DO13, DO13, DO14,
DO14, DO13, DO12

360×290cm

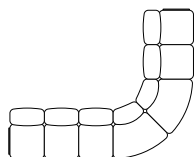

Proposal 14L
DO11, DO13, DO13,
DO14, DO97

350×155cm

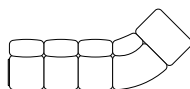

Proposal 15L
DO11, DO13, DO13, DO14,
DO14, DO97

360×220cm

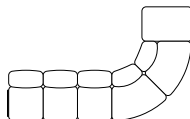

Proposal 15R
DO97, DO14, DO14, DO13,
DO13, DO12

Proposal 16L
DO11, DO13, DO13,
DO15, DO14, DO97

440×168cm

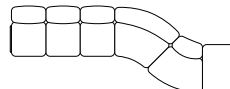

Proposal 16R
DO97, DO14, DO15,
DO13, DO13, DO12

Proposal 17L
DO11, DO13, DO13, DO50,
DO13, DO12

301×234cm

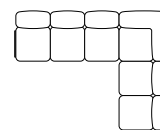

Proposal 17R
DO11, DO13, DO50, DO13,
DO13, DO12

Proposal 18L
DO11, DO13, DO13, DO50,
DO13, DO13, DO97

301×298cm

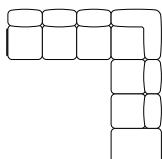

Proposal 19L
DO11, DO13, DO13, DO50,
DO13, DO13, DO12, DO67

301×301cm

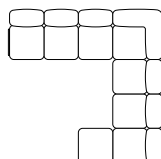

Proposal 20
DO11, DO13, DO50, DO13, DO13,
DO13, DO50, DO13, DO12

395×234cm

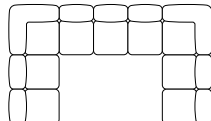

Proposal 21L
DO11, DO13, DO13, DO13,
DO97, DO13, DO13, DO12

338×301cm

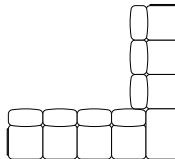

Proposal 21R
DO11, DO13, DO13, DO97,
DO13, DO13, DO13, DO12

Dolmen System

Seat Height
Seat Depth
Height

41cm
64cm
65cm

Proposal 22
DO50, DO50

194×97cm



Proposal 23
DO50, DO13,
DO50

261×97cm

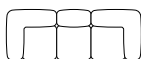

Proposal 24
DO50, DO13,
DO13, DO50

328×97cm



Proposal 25L
DO97, DO13, DO13,
DO50

Proposal 25R
DO50, DO13, DO13,
DO97

298×97cm

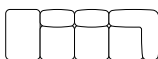

Proposal 26L
DO50, DO97,
DO13, DO50

Proposal 26R
DO50, DO13,
DO97, DO50

328×97cm



Proposal 27L
DO50, DO13, DO13,
DO50, DO97

Proposal 27R
DO97, DO50, DO13,
DO13, DO50

328×164cm

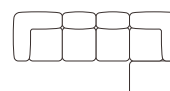

Proposal 28L
DO97, DO13, DO13,
DO13, DO50, DO97

Proposal 28R
DO97, DO50, DO13,
DO13, DO13, DO97

365×164cm

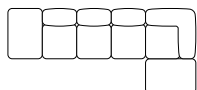

Proposal 29L
DO50, DO13, DO13,
DO15, DO97

Proposal 29R
DO97, DO15, DO13,
DO13, DO50

401×164cm

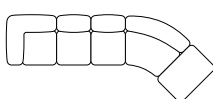

Proposal 30L
DO50, DO13, DO13,
DO15, DO15, DO97

Proposal 30R
DO97, DO15, DO15,
DO13, DO13, DO50

414×246cm

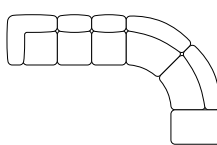

Proposal 31L
DO50, DO13, DO13, DO15,
DO15, DO13, DO50

Proposal 31R
DO50, DO13, DO15, DO15,
DO13, DO13, DO50

414×343cm

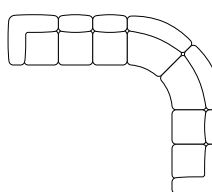

Proposal 32L
DO50, DO13, DO13, DO14,
DO14, DO13, DO50

Proposal 32R
DO50, DO13, DO14, DO14,
DO13, DO13, DO50

387×317cm

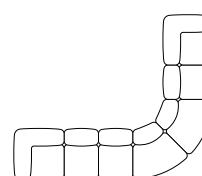

Proposal 33L
DO50, DO13, DO13,
DO14, DO97

Proposal 33R
DO97, DO14, DO13,
DO13, DO50

377×155cm

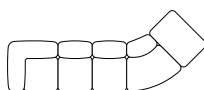

Proposal 34L
DO50, DO13, DO13,
DO14, DO14, DO97

Proposal 34R
DO97, DO14, DO14,
DO13, DO13, DO50

387×220cm

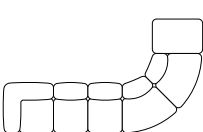

Proposal 35L
DO50, DO13, DO13,
DO15, DO14, DO97

Proposal 35R
DO97, DO14, DO15,
DO13, DO13, DO50

467×168cm

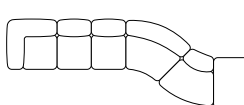

Proposal 36L
DO50, DO13, DO13,
DO50, DO13, DO50

Proposal 36R
DO50, DO13, DO50,
DO13, DO13, DO50

328×261cm

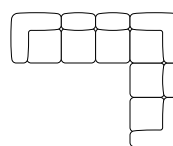

Proposal 37L
DO50, DO13, DO13, DO50,
DO13, DO13, DO97

Proposal 37R
DO97, DO13, DO13, DO50,
DO13, DO13, DO50

328×298cm

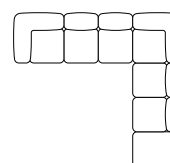

Dolmen System

Seat Height
Seat Depth
Height

41cm
64cm
65cm

Proposal 38L

DO50, DO13, DO13, DO50,
DO13, DO13, DO50, DO97

Proposal 38R

DO97, DO50, DO13, DO13,
DO50, DO13, DO13, DO50

328×328cm

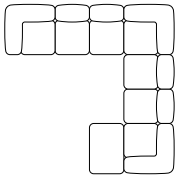

Proposal 39

DO50, DO13, DO50,
DO13, DO13, DO13,
DO50, DO13, DO50

395×261cm

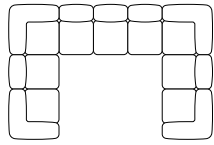

Proposal 40L

DO50, DO13, DO13, DO13,
DO97, DO13, DO13, DO50

Proposal 40R

DO50, DO13, DO13, DO97,
DO13, DO13, DO13, DO50

365×328cm

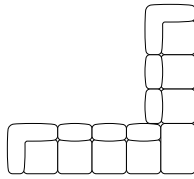

Proposal 41

DO15, DO15,
DO15, DO15

360×180m

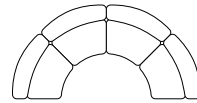

Proposal 42

DO15, DO15, DO13,
DO13, DO15, DO15

494×180m

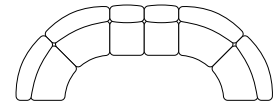

Proposal 43

DO13, DO14, DO15,
DO15, DO14, DO13

474×164m

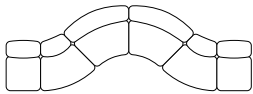

Proposal 44

DO14, DO14,
DO14, DO14

308×154m

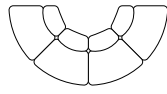

Proposal 45

DO14, DO14, DO13,
DO13, DO14, DO14

442×154m

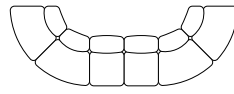

Proposal 46

DO14, DO14, DO15,
DO15, DO14, DO14

548×164m

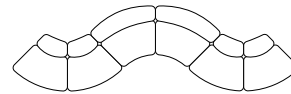

Proposal 47

DO112, DO112,
DO112, DO112

308×154m

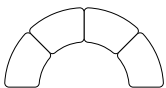

Proposal 48

DO112, DO112, DO67,
DO67, DO112, DO112

434×154m

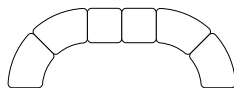

Proposal 49

DO67, DO112, DO112,
DO112, DO112, DO67

474×136m

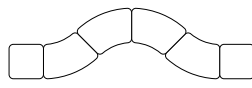

Proposal 50

DO112, DO112, DO112,
DO112, DO112, DO112

548×136m

